

SHORT-WAVE STATIONS OF THE WORLD

MONTHLY
ONE SHILLING

The
**Wireless
World**

*COVERING
EVERY WIRELESS INTEREST*

JULY, 1940

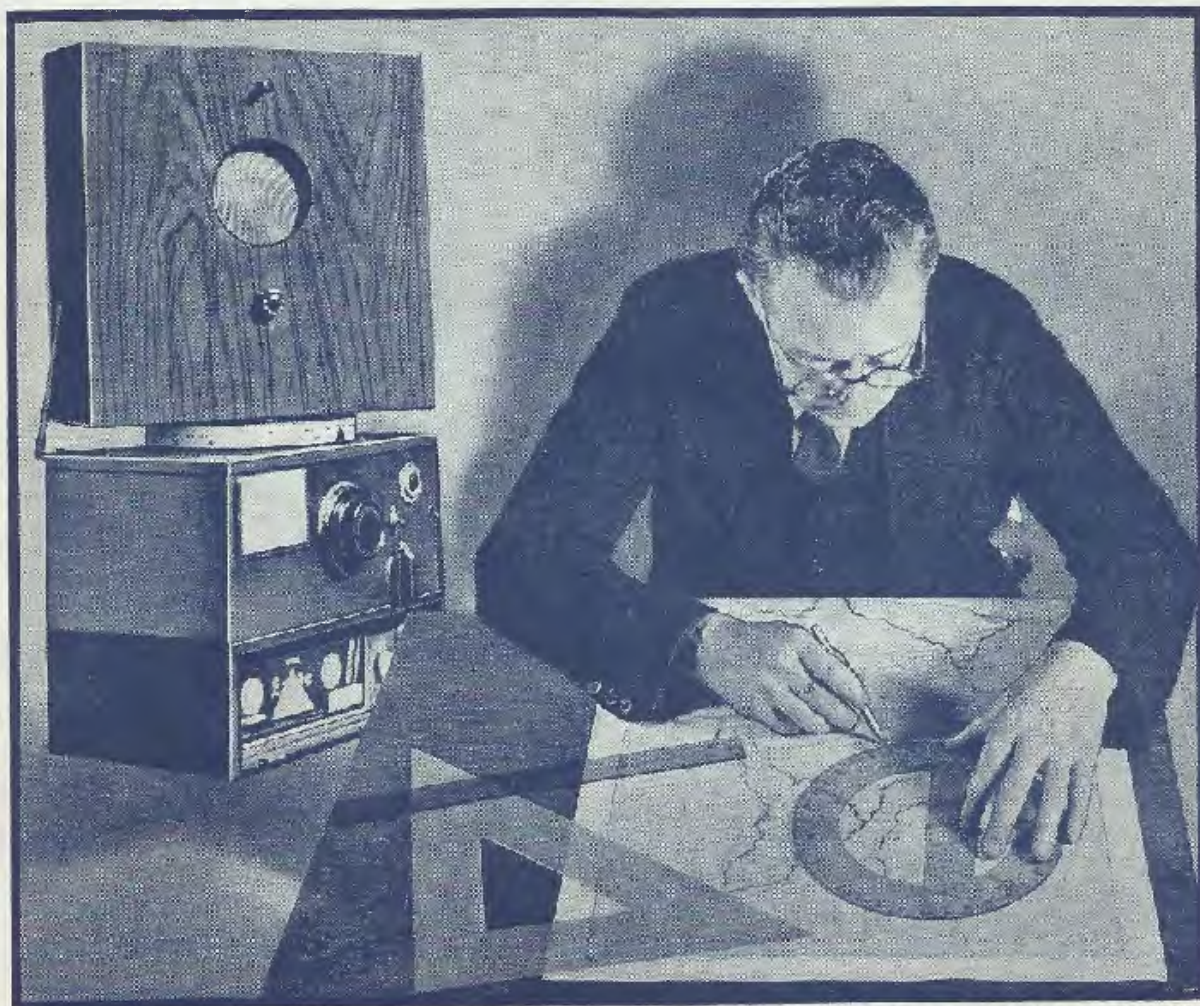

AMATEUR DIRECTION FINDING

"CALLING ALL CARS!"



HIGH in the list of its many contributions towards social progress, Radio has been outstandingly successful in the assistance it affords in the hunting down of criminals. Whether it be a "smash-and-grab" raid, a murder, or merely a stolen car, a few crisp instructions on the Radio from Police Headquarters send a Flying Squad car racing swiftly to the scene.

And it's more than likely that both the Transmitter and the Receiver will be completely equipped with T.C.C. condensers. For Police radio technicians throughout the country have for years past placed implicit trust in the dependability of these familiar little green condensers.

This dependability—this freedom from breakdown under the most arduous conditions—this long service—is something which has been associated with T.C.C. condensers for more than 35 years. And if you are a Radio manufacturer and want to see your service costs cut to a minimum—if you are anxious that your reputation should not be imperilled through breakdowns—then it is sound common sense to discuss your Condenser problems with T.C.C. Technical experts. Remember T.C.C. make nothing but condensers—as specialists their research facilities are without equal in this country.

T.C.C.
CONDENSERS

Advertisement of the Telegraph Condenser Co. Ltd., Wales Farm Road, North Acton, London, W.3.

GA 9231

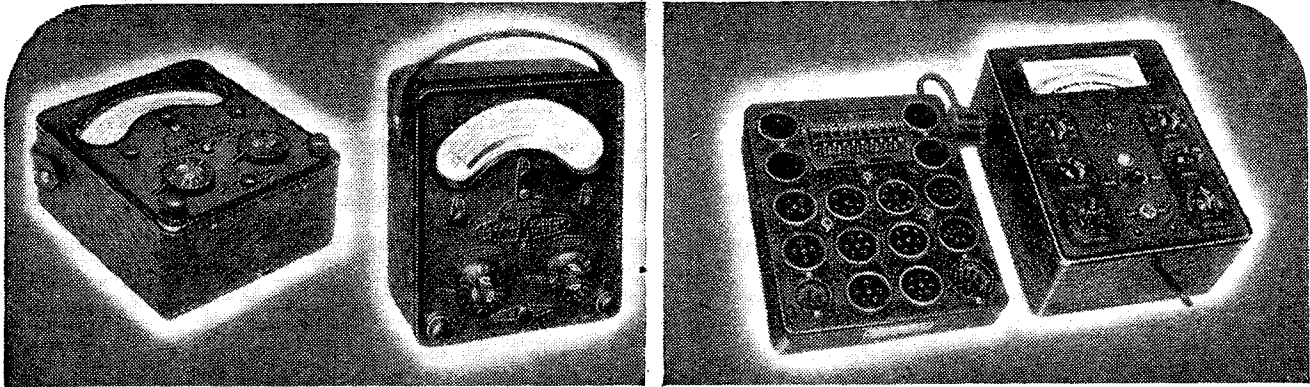

46-range Model 7
Universal AvoMeter.

40-range Model 40
Universal AvoMeter.

"Avo" Valve Tester with Universal Panel.

PRECISION METERS

that Master every Testing Problem

HIGH accuracy, simplicity, exceptional versatility and proven reliability have won for "AVO" Instruments a world-wide reputation for supremacy wherever rapid precision test work is demanded. There is an "AVO" instrument for every essential electrical test.

OTHER "AVO" INSTRUMENTS (not illustrated)
 High Resistance AvoMinor. The "AVO" Bonding Meter.
 "AVO" Low Resistance Ohmmeter. The "AVO" Milliohmmeter.
 The AvoDapter. 9-pin AvoCoupler.

Sole Proprietors and Manufacturers:

THE AUTOMATIC COIL WINDER & ELECTRICAL EQUIPMENT Co., Ltd., Winder House, Douglas St., London, S.W.1

Phone: Victoria 3404-7.

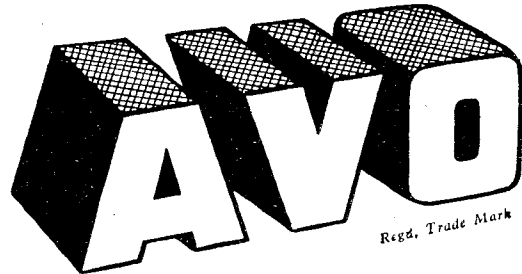

ELECTRICAL MEASURING INSTRUMENTS

BRITISH MADE

Write for fully descriptive literature dealing with any instrument in which you are interested, and for current prices.

All-Wave "Avo" Oscillator

"Avo" Test Bridge

Universal AvoMinor

D.C. AvoMinor

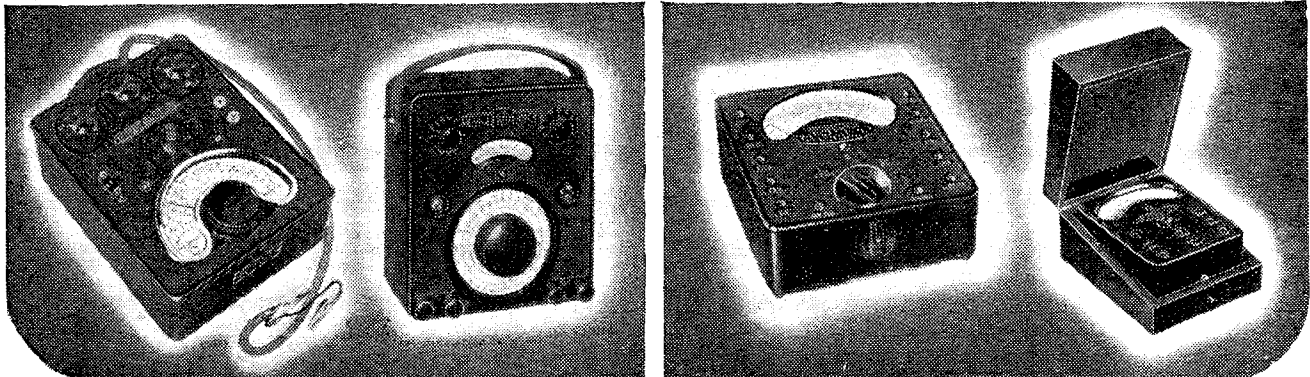

MID-WEST RADIO

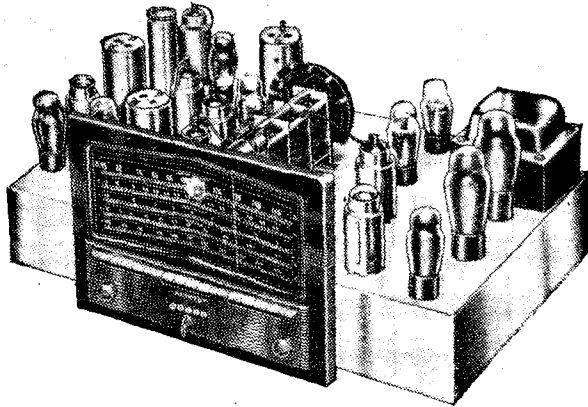

A NEW CONCEPTION OF WORLD ENTERTAINMENT

Mid-West Radio brings the world to your fireside—but that is a commonplace in these days.

Mid-West Radio achieves much more. It gives a quality of reproduction that makes ordinary radio sound like a fair-ground steam band compared with a symphony orchestra.

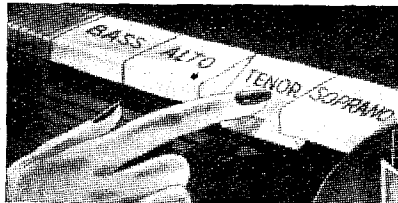

THE WONDERFUL Organ-Fonic TONE FILTER

This unique feature consists of a series of organ type resonating pipes arranged in graduated sizes. They improve reproduction beyond belief, giving to both voices and music their true naturalness, colour, vibrancy and reality. If you want to blend harmonies, to enrich the tone, to accentuate the bass or treble all you need to do is to touch the appropriate Organ Key Control. You are master of the music—"playing" the set to get the musical effects you desire and

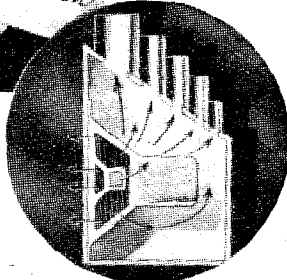

controlling the tone values as a musical director controls his orchestra.

SPECIFICATION

12 or 17 valve Chassis, 5 wave-bands, 4½-2,400 metres, 10 watts output, organ fonic tone filter with dual speakers, four separate tone controls—motor or manual tuning, Selectivity approx. 3K.C. Sensitivity approx. 1½ microvolts.

12 valve Chassis complete with speaker **£25-10-0**
 12 valve Table Model **£32-10-0**
 17 valve chassis with speakers **£32-10-0**
 17 valve Table Model **£39-10-0**
 17 valve Console **£45-0-0**
 17 valve Autoradiogram **65 gns.**

Full particulars from
ELITE RADIO, 23A CONDUIT ST., REGENT ST., W.1
 Telephone : MAYFAIR 4088

RAYMART

CRAFT A CREED

VARIABLE CONDENSERS

Our standard range of micro-variables are of all-brass construction with heavy gauge vanes and a special device electrically short-circuits the ball-bearing spindle, giving noise-free operation with smooth control and avoiding the troubles inherent with old-fashioned pigtails.

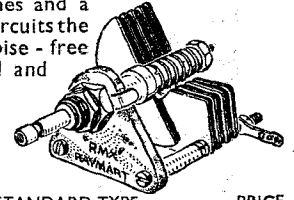

Ceramic insulation (RMX) is the latest product of the laboratories. Note how it improves at high frequencies.

Loss factor at	300 kc/s.	50,000 kc/s.	STANDARD TYPE	PRICE
Quartz	1.0	1.1	VC15X 15 mmfd.	1/7
"RMX"	4.1	3.2	VC40X 40 mmfd.	1/10
Micalax	11.9	18	VC100X 100 mmfd.	2/2
Porcelain	70	85	VC160X 160 mmfd. (.00016 mfd.)	2/6
Moulded material	100	260	VC250X 250 mmfd. (.00025 mfd.)	2/10

(Calculated from power factor with quartz taken as unity at 300 kc/s.) (All types can be ganged.)

NEW MIDGET TYPE

In response to a high demand, particularly from Government Contractors and Aircraft Radio manufacturers, for a high frequency tuning condenser, occupying a minimum amount of space, we have produced a new range of Midget Micro-variables. Precision built on the same lines as our standard range and with the following features not found in any competitive range.

MIDGET TYPE	(Approx. max. capacity)	PRICE
MC15X	15 p.f.	1/8
MC40X	40 p.f.	1/11
MC100X	100 p.f.	2/3
MC7DX	Double spaced 7 p.f.	1/8
MC15DX	Double spaced 15 p.f.	1/10

Shaft turned from solid metal overall, giving accuracy not to be found in condensers where the shaft is fabricated from a drawn pin rod. Ball bearing rotor with long bearing, so eliminating side play and at the same time giving an extremely smooth bearing. Both ball races electrically shorted internally by special Phosphor Bronze shorting brushes, inside bearing. First-grade Ceramic and all brass construction.

The New Raymart Catalogue shows dozens of New Shortwave Components. Post free for 2½d. stamp.

RADIOMART 44, HOLLOWAY HEAD BIRMINGHAM, 1
 G5N1 (Birmingham) LTD.

TUNGSRAM VALVES

THE VITAL LINK IN YOUR SET

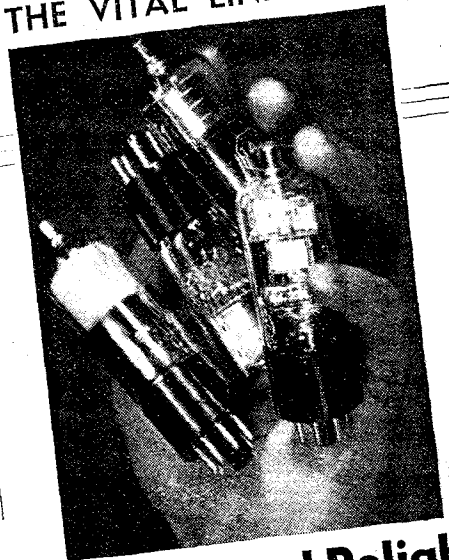

for

Efficiency and Reliability
 EQUIVALENT VALVES FOR ALL MAKES OF SETS

Sole Distributors in GREAT BRITAIN and EIRE :
SIEMENS ELECTRIC LAMPS AND SUPPLIES LIMITED
 38-9, UPPER THAMES STREET, LONDON, E.C.4

for
**LIGHTNING
ASSEMBLY**

**Simmonds
Speed Nuts**
(PATENTS APPLIED FOR)

Simmonds Speed Nuts eliminate ordinary nuts and lock washers. They halve handling time, reduce assembly operations and effect considerable savings in time and costs. They are unaffected by vibration and absorb any movement due to temperature changes. Fitted with amazing speed, Speed Nuts are extremely flexible in adaptation, being invaluable for "blind" locations. For plastics, glass and porcelain, Speed Nuts are the perfect fastening.

Enquiries are invited by Manufacturers and Designers. Our Development Department will be pleased to collaborate and work out the most effective designs to solve your assembly problems.



SIMMONDS AEROCESSORIES LTD
GREAT WEST ROAD, LONDON.



M-R-SUPPLIES

Invite your urgent attention to the following **EXCLUSIVE BARGAIN OFFERS** of high-grade Electrical Equipment:

AUTODAPTOR VIBRATOR UNITS. Ideal for H.T. supply independent of supply mains. Input 6 volts from car battery. Output 115 volts 50 m.a. D.C. with 25-volt A.C. tap for 43 output valve heater. These brand new instruments cost £6 and were imported from U.S.A. to run a midget receiver in a car. Thus they are suitable for mobile radio or small amplifier or for A.R.P. In strong metal container, 5 1/2 in. x 4 in. x 3 1/2 in. with long input and output leads. D.C. output is fully smoothed. We offer 150 only at 25/- each.

ROTHERMEL-BRUSH D.104 MICROPHONE INSETS. The heart of the famous 5-guinea D.104 Microphone, only require suitable housing. Very exceptional opportunity—last few at 22/6 each. Can be used just as supplied.

MINIATURE P.M. MOVING COIL UNITS. The heart of the finest Moving Coil Microphone. Diameter only 3 in., fitted very latest alumi magnet. Fine sensitivity and response. Imped. 12 ohms. Many hundreds now in use for intercommunication, public address and for extension loudspeakers. A very popular offer at 12/6.

ROTARY CONVERTERS (now very scarce). E.D.C., complete with silence cabinet and radio filter. Input 220/220 v. D.C., output 220 v. A.C. 120 watts, fine condition. £6/15/-, Westinghouse, input 100/120 v. D.C., output 110 v. A.C. 1,500 watts (1.5 kva) very useful and efficient machine in perfect condition (dist. £28). £2/10/-, Anode converter, comprising 1 h.p. 100/120 v. D.C. motor direct coupled to M.L. generator delivering 100 v. 150 m.a. D.C. and 6 v. 5 amp. D.C. Ideal for amplifier, etc., £6/10/-, Also in stock some brand new Capacitor Start A.C. Motors, 1/8th and 1/4th h.p. Stocks very difficult to maintain—please enquire.

SLIDING RHEOSTATS. Fully enclosed "Safety First" pattern. Fine smooth action. Following ratings in stock: 10 ohms 3 amps, 50 ohms 1 1/2 amps, 100 ohms 1 amp, 200 ohms 7 amp, 400 ohms 7 amp, and 550 ohms 5 amp. Any one, 12/6. **HEAVY DUTY MOTOR STARTERS** (no-volt release), 250/550 volts, 2-5 h.p., with eight stud contacts, 22/6.

POST OFFICE STANDARD RESISTANCE BOXES (Plug type). Taps 50, 100, 200, 300, 400, 1,000 and 2,000 ohms (total 4,050 ohms). All perfect as new, 25/-.

MAINS TRANSFORMERS. Really first-class job by Standard Telephones. Primary 200/250 v., secondary 250-0-250 v. 120 m.a., 2.5 v. 5 amps, and 5 v. 2 amp, 8/6. Also **STEP-DOWN TRANSFORMERS** for chargers, etc., prim. 200/250 v., secondary 7, 11 and 15 v. (tapped) at 2 amps, 10/11. Or secondary, 22 v. 2 amps, 12/-.

SERVICE EQUIPMENT. "Avo" Valve Tester complete with British and U.S.A. valve sockets and "dealer" panel, 2/11. Philco Short-wave Oscillator and Echo Med. and Long ditto (less batteries), £8/10/- the pair.

ROTHERMEL DE LUXE PIEZO-CRYSTAL PICK-UPS. (Remarkable opportunity for the finest pick-up ever produced.) The original 4-guinea lift-head model with ball-bearing tracking arm, brand new and fully guaranteed, 37/6 each. We now have hundreds of very satisfied customers for these.

Also **FINAL OFFER** of the **NEW JUNIOR PIEZO-CRYSTAL** at special price of 18/6. Also **REPLACEMENT HEADS** for GARRARD arm, bringing your old machine right up to date with a revelation in performance, 29/6. Entrust your pick-up order to us—we have the finest bargains in high-quality models.

LOW TENSION RECTIFIERS (Standard Telephones). Delivery 12 volts 1 1/2 amps. An efficient charger can be very easily made with these permanent metal rectifiers, 10/9.

RADIO INTERFERENCE SUPPRESSORS (Post Office spec.). Definitely cut out all interference introduced through house mains—hundreds in use. Easily fitted—diagram supplied. Complete, 3/6.

PLEASE ENQUIRE FOR RECORD CHANGERS, GRAMO. MOTORS, TIME SWITCHES, RELAYS, MICROPHONES, BATTERY CHARGERS, METERS, etc.

M.R. SUPPLIES, 63, New Oxford St., London, W.C.1. 'Phone: MUS. 2958

A MIDGET OF OUTSTANDING SUCCESS

Ambassador
MODEL M.U. 540
CASH PRICE
£7.0.0
in Walnut Cabinet.
De Luxe Model in Bird's
Eye Maple Cabinet
£7.2.6

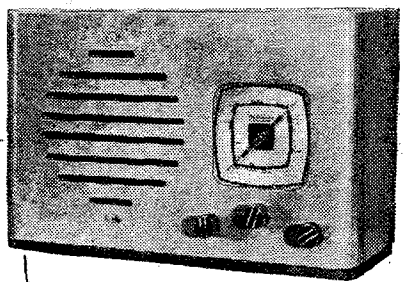

BRIEF SPECIFICATION:— SETS A NEW STANDARD IN RADIO!

Equally suitable for Home and Overseas use • AC/DC mains operated 5-valve Superhet with AVC • 2-wave bands 13/50 metres and 200/550 metres • Large 6 3/4" Electro Dynamic Reproducer • Supplied complete with aerial attached • No earth required • Can be adapted to any voltage



Write for literature of the above and other models to:—

R. N. FITTON LTD., BRIGHOUSE, YORKS, ENGLAND

• All export orders receive preference.

ROLA

TRANSFORMER LAMINATIONS

Stamped from High Grade Steel, wired and packed in the same consecutive order as they leave the press, ROLA laminations create low transformer costs by their saving on labour. Eight standard sizes of E's and I's are available from stock, together with associated clamps and covers. Core dimensions 1/16" to 1 1/2". A comprehensive Bulletin with design data for manufacturers will be sent on request.

BRITISH ROLA LIMITED
MINERVA ROAD, PARK ROYAL, N.W.10
WILLESDEN 4322

AND NOW . . . MCCLURE AMPLIFIERS

YOU already know our FEEDER UNITS, the outstanding qualities of which have been recommended by the "Wireless World" in words which we cannot better.

AUDIO AMPLIFIERS

worthy of these radio units are now available, at prices well within the means of all. Genuinely flat response from 30 to 15,000 cycles. Hum level inaudible at full gain.

These are, of course, also suitable for use independently as gramophone amplifiers, or, in a modified form with an additional stage, as microphone amplifiers.

Model ACA 16. 3-stage A.C. Amplifier, consisting of triode stage followed by phase-splitter driving two large triodes in push-pull with undistorted output of 14-watts. Resistance coupled throughout. Input voltage of 3.5 volts. Alternative input of 1.5 volts, if required. H.T. consumption; 180 m.A. at 400 v. Generous power pack, with spare H.T. of 25 m.A. at 400 v. and L.T. of 4.5 amp. at 4 v.

Price, complete with valves £8-18-6

Universal models also available.

Enquiries invited for larger installations suitable for Public Address of all kinds.

Send for particulars to:

JOHN MCCLURE LTD.

ERSKINE ROAD, N.W.3
Phone: PRImrose 5435-6

PREMIER RADIO

NEW PREMIER S.W. A.C. RECEIVER KIT

In response to many requests we have now produced an A.C. version of the popular Premier Short Wave SG3 Kit. Circuit: Pentode H.F. Stage, Pentode Detector, Beam Power Output, and F.W. Rectifier. 200-250 v. A.C. Operation. Built in Power Pack. Hum-free operation. For use in Phones or P.M. Speaker. Complete Kit of Parts with drilled chassis, all components. Plug-in Coils covering 13-170 metres, 4 valves and full instructions and circuits £4-10-0. Completely wired and tested £5-10-0. Send for full details.

"LEARNING MORSE"

- Premier Morse Practice Key on Bakelite Base and Brass Movement ... **3/3**
- General Purpose Morse Key ... **5/10**
- Heavy Duty TX Key on Cast Base ... **10/-**
- Bakelite Buzzers ... **1/9**
- Complete Kit of Parts for Valve Oscillator as described in W.W. "Learning Morse" ... **25/-**

SHORT-WAVE GEAR

- Short-Wave Coils, 4- and 6-pin types, 13-26, 22-47, 41-94, 78-170 metres, 2/- each, with circuit. Premier 3-Band S.W. Coil, 11-25, 19-43, 38-86 metres. Suitable any type circuit, 2/11.
- 4-pin or 6-pin Coil Formers. Plain or Threaded, 1/2 each.
- Utility Micro Cursor Dials, Direct and 100 : 1 Ratios, 4/3.
- New Premier 2-Gang S.W. Condenser. 2 x .00015 mf. with integral slow motion, 5/9.
- Bakelite Dielectric Variable Condensers. .0003 and .0005 mf. Suitable Tuning or Reaction, 1/6 each.
- Short-Wave H.F. Chokes. 10-100 m., 10/- d. each. High grade Pie Wound U.S.A. type, 1/9 each.
- Lissen Dual Range Screened Coils. Medium and Long Waves, 2/9 each.

PREMIER 1940 HIGH FIDELITY AMPLIFIER KITS

- Each Kit is complete with ready drilled chassis, selected components, specially matched valves and full diagrams and instructions.
- | | |
|---------------------------|--|
| | Completely Kit of Parts Wired and with Valves. Tested. |
| 3-watt A.C. Amplifier ... | £2 6 6 £3 4 0 |
| 3-watt A.C./D.C. " ... | £2 6 6 £3 4 0 |
| 6-watt A.C. " ... | £5 2 6 £7 0 0 |
| 8-10-watt A.C./D.C. " ... | £5 5 0 £6 2 6 |
| 15-watt A.C. " ... | £6 14 0 £8 2 6 |
- Black Crackle Steel Cabinet 15/- extra.

SHORT-WAVE CONDENSERS

- Trolitic insulation. Certified superior to ceramic. All-brass construction. Easily ganged.
- | | | | |
|---------------|-----|----------------|------|
| 15 m.mfd. ... | 1/9 | 100 m.mfd. ... | 2/3 |
| 25 m.mfd. ... | 2/- | 160 m.mfd. ... | 2/6 |
| 10 m.mfd. ... | 2/- | 250 m.mfd. ... | 2/11 |

MOVING COIL SPEAKERS

- All complete with transformer. Rola 8 in. P.M.s, 16/6; 10 in. P.M.s, 22/6; G.12 P.M.s, 66/-.
- #### ENERGISED MODELS
- Plessy 8 in., 175 ohm. field, 7/6; G.12 energised, 59/6. 10 in. B.T.H. 1,600 ohm. field, less transformer, 11/6.

PREMIER SHORT-WAVE KITS for OVERSEAS NEWS

Incorporating the Premier 3-Band S.W. Coil. 11-86 Metres without coil changing. Each Kit is complete with all components, diagrams and 2-valve valves. 3-Band S.W. 1 Valve Kit, 14/9. 3-Band S.W. 2-Valve Kit, 22/6.

DE LUXE S.W. KITS

Complete to the last detail, including all Valves and coils, wiring diagrams and lucid instructions for building and working. Each Kit is supplied with a steel Chassis and Panel and uses plug-in coils to tune from 13 to 170 metres.

- 1 Valve Short-Wave Receiver or Adaptor Kit ... **20/-**
- 1 Valve Short-Wave Superhet Converter Kit ... **23/-**
- 1 Valve Short-Wave A.C. Superhet Converter Kit ... **26/3**
- 2 Valve Short-Wave Receiver Kit ... **29/-**
- 3 Valve Short-Wave Screen Grid and Pentode Kit ... **68/-**

MAINS TRANSFORMERS Wire-ends. All L.T. Windings Centre-Tapped

- SP. 301 300-300 v. 150 m.a. 4 v. 2-3a, 4 v. 2-3a, 4 v. 1a, 4 v. 1a ... **15/-**
- SP. 350A 350-350 v. 100 m.a. 5 v. 2a (not C.T.), 6.3 v. 2-3a, ... **14/-**
- SP. 350B 350-350 v. 100 m.a. 4 v. 2-3a, 4 v. 2-3a, 4 v. 2-3a ... **14/-**
- SP. 351 350-350 v. 150 m.a. 4 v. 1-2a, 4 v. 2-3a, 4 v. 3-4a ... **15/-**
- SP. 352 350-350 v. 150 m.a. 5 v. 2a, 6.3 v. 2a, 6.3 v. 2a ... **15/9**

MATCHMAKER UNIVERSAL OUTPUT TRANSFORMERS

Will match any output valves to any speaker impedance. 11 ratios from 13 : 1 to 80 : 1. 5-7 watts, 15/9. 10-15 watts, 20/6. 20-30 watts, 35/-.

Auto Transformers. Step up or down. 100-125 v. to 200, 230 or 250 v. A.C., 60 watts, 9/11; 125 watts, 13/6; 250 watts, 18/6.

- L.T. Transformers, all C.T.
- | | | | |
|-----------------|------|-------------------|------|
| 4 v. 2-3 a. ... | 9/11 | 6.3 v. 2-3 a. ... | 9/11 |
| 2.5 v. 5 a. ... | 9/11 | 7.5 v. 3 a. ... | 9/11 |
| 5 v. 2-3 a. ... | 9/11 | 12 v. 3-4 a. ... | 15/- |

Lissen Hypernik GPP Driver Transformers. Ratio 8 : 1. 4/3.

- Push-Pull Driver Transformers ... **6/6**
- Universal Output Transformers. 11 Ratios.
- Single or Push-Pull ... **6/6**

GRAMOPHONE MOTORS and PICK-UPS

Special Offer of Record Auto-Changer Units for A.C. Mains by famous manufacturer. Play 8 records. Latest type Magnetic Pick-up, Auto-stop, Start and Rejector. Limited number only at £4.19.6. Carriage Paid.

- #### A.C. Gramophone Motors.
- 100-250 v. 12-inch turntable. Auto-stop. Hum free ... **35/-**
 - A.C./D.C. Model ... **52/6**

- #### A.C. Gramophone Unit.
- Complete motor and pick-up. Auto-stop and start ... **52/6**
 - A.C./D.C. Model ... **77/6**

- #### Premier Pick-up Heads.
- Will fit any tone-arm ... **5/3**

ANOTHER SPECIAL OFFER. Rothermel Brush Piezo Crystal Pick-ups New Junior P.U. with arm, 19/6. Standard S.8. Model with arm, 29/6. P.U. head only, De Luxe Model, 19/6.

REPLACEMENT VALVES FOR ALL SETS

Europa Mains Valves, 4 v. A.C. Types A.C./H.L., A.C./L., A.C./S.G., A.C./M.S.G., A.C./H.P., A.C./V.H.P., A.C.P., all 5/3 each. A.C./H.P., A.C./V.H.P., 7-pin, 7/6. A.C./Pens, I.H., 7/6; A.C./P.X.4, 7/3; Oct. Freq. Changers, 8/6; Double Diode Triodes, 7/6; 3½-watt D.H. Triode, 9/9. 350 v. F.W. Rect., 5/6; 500 v., 6/6. 13 v. 2 amp. Gen. Purpose Triodes, 5/6; H.F. Pens. and Var.-Mu. H.F. Pen., Double Diode Triodes, Oct. Freq. Changers, 8/6 each. Full and Half-wave Rectifiers, 6/6 each.

Triad U.S.A. Valves. We hold the largest stocks of U.S.A. tubes in this country and are sole British Distributors for TRIAD High-grade American Valves. All types in stock. Standard types, 5/6 each. All the new Octal Base tubes, at 6/6 each.

Clearance Line U.S.A. Valves. U.S.A. Types, 24, 30, 35/51, 55, 56, 57, 71, 85, 2A5, 2A6, 2A7, 2B7, 6A7, 210, 250, 12Z3, all 2 for 3/-.

NEW PREMIER 1940 5v5 COMMUNICATIONS RECEIVER

£9.9.0
Send for details.

PREMIER BATTERY CHARGERS for A.C. Mains

Westinghouse Rectification complete and ready for use

To Charge:	6 volts at 1 amp. 22/6
2 volts at ½ amp. 11/9	12 volts at 1 amp. 24/6
6 volts at ½ amp. 19/-	6 volts at 2 amps. 37/6

ALL ENQUIRIES MUST BE ACCOMPANIED BY 2½d. STAMP.

YOU MUST HAVE OUR GIANT 1940 ILLUSTRATED CATALOGUE AND VALVE MANUAL OVER 100 PAGES. PRICE **6d.**

PLUS POSTAGE 2½d.

PREMIER RADIO CO.

ALL POST ORDERS to: JUBILEE WORKS, 167, LOWER CLAPTON ROAD, LONDON, E.5 (Amherst 4723).
CALLERS to: Jubilee Works, or 169, Fleet Street, E.G.4 (Central 2833), or 50, High Street Clapham, S.W.4 (Maccalvey 2381).

Osram Valves

MADE IN ENGLAND.



An Example.

TYPE Z62

For H.F. amplification from 50 down to $3\frac{1}{2}$ metres, I.F. amplification, detection or high gain high fidelity audio.

OSRAM VALVES are all British—they are manufactured throughout in England and every valve is fully tested under working conditions.

TO SUIT ALL PURPOSES

For the amateur and experimenter, specialised types are available, and of particular interest are the valves for short-wave reception, and power amplification.

Osram Valves for SHORT WAVES are designed with careful attention to all the essential features—high input impedance, low leakage, short leads, minimum electron transit time.

For POWER AMPLIFICATION, Osram Valves have always been famous.

*Technical data sheets
are available for each
type of Osram Valve.*

THE GENERAL ELECTRIC CO. LTD.,
Magnet House, Kingsway, London, W.C.2

The Wireless World

COVERING EVERY WIRELESS INTEREST

30th Year of Publication

Proprietors : ILIFFE & SONS LTD.

Editor :
HUGH S. POCOCK.

Editorial,
Advertising and Publishing Offices :
DORSET HOUSE, STAMFORD STREET,
LONDON, S.E.1.

Telephone : Waterloo 3333 (50 lines).
Telegrams : "Ethaworld, Sedist, London."

COVENTRY : 8-10, Corporation Street.
Telegrams : Telephone :
"Autocar, Coventry." 5210 Coventry.

BIRMINGHAM :
Guildhall Buildings, Navigation Street, 2.
Telegrams : Telephone :
"Autopress, Birmingham." 2971 Midland (5 lines).

MANCHESTER : 260, Deansgate, 3.
Telegrams : Telephone :
"Iliffe, Manchester." Blackfriars 4412 (4 lines).

GLASGOW : 26B, Renfield Street, C.2.
Telegrams : Telephone :
"Iliffe, Glasgow." Central 4857.

PUBLISHED MONTHLY.
Price : One Shilling
(Publication date 20th of preceding month.)

Subscription Rates :
Home and Abroad, 14/- per annum.

As many of the circuits and apparatus described in these pages are covered by patents, readers are advised, before making use of them, to satisfy themselves that they would not be infringing patents.

No. 1057

Vol. XLVI. No. 9

JULY 1940

Contents

EDITORIAL COMMENT	315
AMATEUR DF: DESIGN OF A SIMPLE DIRECTION FINDER. By Alexander Black	316
PROBLEM CORNER	319
PRINCIPLES OF FAULT-TRACING: Part II—APPLYING BASIC IDEAS TO SPECIFIC CASES. By W. H. Cazaly	320
UNBIASED. By Free Grid	324
LETTERS TO THE EDITOR	325
SHORT-WAVE BROADCASTING STATIONS	327
SHORT-WAVE RECEIVING CONDITIONS	328
APPARATUS REVIEWED	329
DIVERSITY RECEIVERS: EQUIPMENT IN SOUTH AFRICA	330
CURRENT TOPICS	331
NEWS IN ENGLISH FROM ABROAD	333
MORSE KEY MANIPULATION. By H. F. Jones	334
THE "DOUBLE-DECCA": Test Report	336
RATIONALISING BROADCAST RECEIVERS. By J. A. Sargrove	338
RANDOM RADIATIONS. By "Diallist"	343
RECENT INVENTIONS	345

INTEREST and ENTERTAINMENT

The limitations of the so-called all-wave type of receiver is most evident when listening in on the lively ether on 7 to 550 metres ..

WITH A

TROPHY

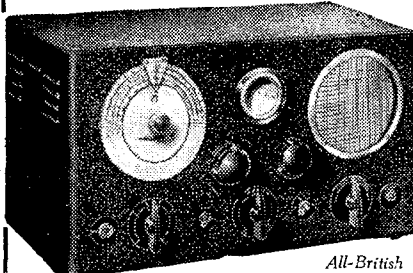

All-British

Fully Guaranteed.

PETO SCOTT CO. LTD., 77. (WMT), City Road, London, E.C.1. Tel.: Oldsoid 9875.

41, High Holborn, W.C.1. Tel.: Holborn 3248.

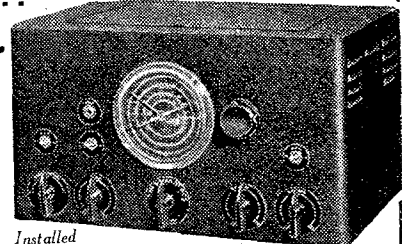

Installed at RADIO ROYAL

Deferred terms. Send now for lists. Demonstrations—note London addresses. Available from all Dealers. Scotland: Clydesdale Supplies. Manchester: Wellworth Radio Ltd.

"6"
Recommended receiver in the junior communications class, 6 valves, electrical bandspreading and other refinements for reliable reception on 6.5 to 545 metre. **£11.11.0**

"8"
A new super 8-valve A.C. communications model. R.F. all 5 bands, 7 to 550 metres. Solo-knob bandspread. **£14.19.6** Speaker 46/3 extra

HIGH PAY!

AND SECURITY FOR ENGINEERS

NOW is the time for every man interested in any branch of Engineering to equip himself for a position of responsibility and high pay by becoming *Technically Qualified!*

Practical experience alone is not sufficient; it is the man who has studied the technical side of Engineering and *modern production methods* who can command big money.

The Engineer who can place a few letters after his name such as **A.M.I.Mech.E., A.M.I.E.E., A.M.I.P.E.** (*Associate Member Institution of Production Engineers*), will always stand head and shoulders above the unqualified man.

FREE 208-PAGE HANDBOOK

Send to-day for "**ENGINEERING OPPORTUNITIES.**" This remarkable guide describes the easiest way of passing the **A.M.I.C.E., A.M.I.Mech.E., A.M.I.E.E., A.M.I.A.E., A.M.I.P.E., A.M.I.W.T., A.M.I.R.E.**, and similar Examinations. The handbook also gives details of Courses in all branches of **Civil, Mechanical, Electrical, Motor, Aeronautical, Radio and Production Engineering, Draughtsmanship, Tracing, Inspection, Building, Government Work, etc.**, and explains the unique advantages of our Nationally-Organised Employment Department.

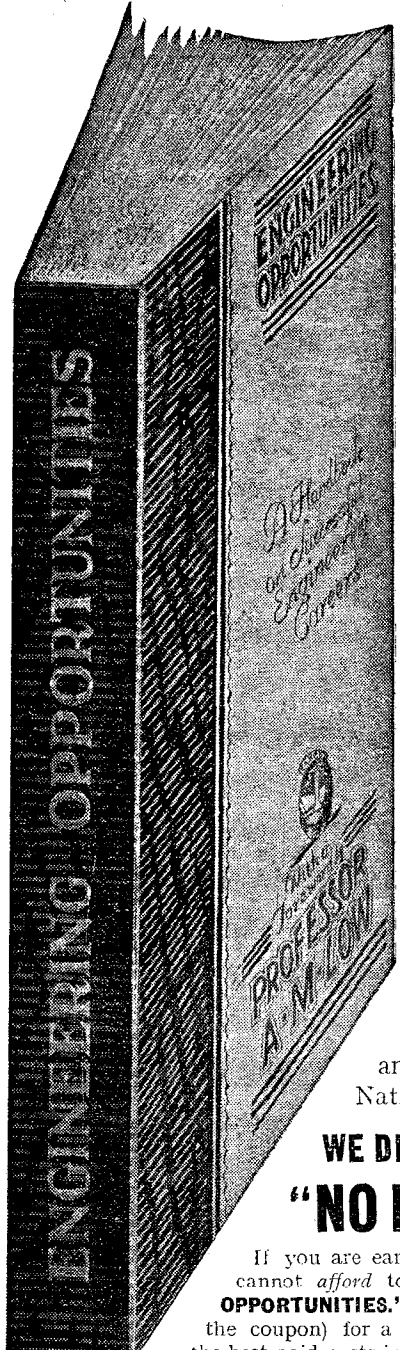
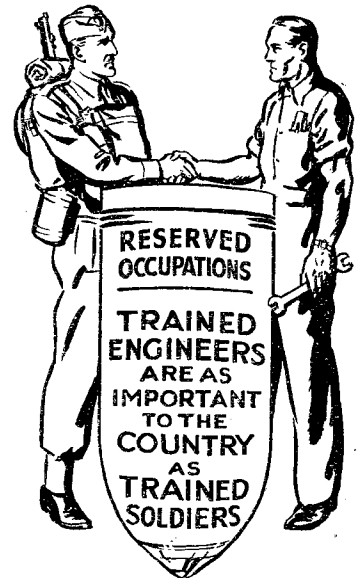

**WE DEFINITELY GUARANTEE
"NO PASS—NO FEE"**

If you are earning less than £10 a week, you cannot afford to miss reading "**ENGINEERING OPPORTUNITIES.**" You should write (or send the coupon) for a copy of this 208-page guide to the best-paid posts immediately—**FREE** and post free.

**BRITISH INSTITUTE OF
ENGINEERING TECHNOLOGY**

387, SHAKESPEARE HOUSE,
17, STRATFORD PLACE, LONDON, W.1

-----TEAR OFF HERE-----
FREE COUPON

BRITISH INSTITUTE OF
ENGINEERING TECHNOLOGY,
387, Shakespeare House, 17-19, Stratford Place,
W.1

Please forward **Free of cost or obligation** of any kind, your 208-page Handbook "**ENGINEERING OPPORTUNITIES.**"

NAME

ADDRESS

The Wireless World

COVERING EVERY
WIRELESS INTEREST

ESTABLISHED
1911

No. 1057. Vol. XLVI. No. 9.

JULY 1940

Price One Shilling

Editorial Comment

Simplification and Rationalisation

DURING the early days of the war we warned readers that they might have to face a drastic simplification in broadcasting, not only in the transmissions, but also at the receiving end. That prophecy, like many another made before it was realised that many months of relatively inactive warfare were before us, seemed at first to have gone rather badly astray. But now that the *blitzkrieg* is upon us in earnest, it is realised that the broadcast receiver industry must make sweeping changes if it is to continue to supply home demands and, what is vastly more important, extend its export trade. During the last few months our correspondence from abroad has proved conclusively that more foreign importers are now interested in British wireless apparatus than ever before, and we are convinced that real opportunities exist for the industry, provided it can grasp them.

When we first raised the question of simplification it must be admitted that we were thinking solely of the home consumer; we considered that success in the export market could be attained through such aids to efficiency as standardisation of components.

A contributor in this issue carries the whole matter a stage further by proposing, for both home and export production, a more drastic simplification than has hitherto been envisaged. Briefly, it is proposed that, as a first step, British manufacturers should concentrate on a single range of valves, building around that range the best possible sets that can be devised without making inroads on supplies of vital material, and especially of imported material. But this is to be only a beginning. Our contributor goes on to make even more sweeping proposals by suggesting that, for at any rate the

mass market, we might reduce the number of mains-operated valve types to three; two of these would have battery-fed counterparts. He discusses at some length the technical possibilities of designing receivers around the extremely limited series of valves. Provided that technical and other difficulties can be overcome, the attractions of such a scheme are obvious; productive efficiency should be high, and the overseas trader would find in the fact that he had only to stock three types of replacement valves a powerful argument in favour of handling British sets.

Team Work Needed

It is not intended here to discuss the scheme in detail, still less to attempt to criticise it. No plan such as that proposed can be put into successful operation without a much closer collaboration between all branches of the industry than anything it has known before. The closest team work, and, almost inevitably, a measure of sacrifice on the part of some of the interests concerned, would clearly be necessary. But the present times call for drastic action, and we believe that wireless people have, as befits those in a young industry, a greater flexibility of mind than is to be found in old-established fields of activity.

Of one thing we are certain. Even if the scheme under discussion is found on examination to be impracticable, it is only by the adoption of some other plan of an equally revolutionary nature that the British wireless industry will be enabled to make its fullest contribution to the war effort. Further, team work is needed, and wasteful competition between ourselves is a luxury for which we must wait until peace returns.

Amateur DF

DESIGN OF A SIMPLE DIRECTION FINDER

By ALEXANDER BLACK

A VERY interesting branch of wireless experimenting for amateurs is that connected with the directional properties of frame aerials. Direction finding by wireless is primarily used by ships at sea during foggy weather and, of course, by aircraft as well. It has now reached a state of great reliability and precision in these spheres of usefulness.

Up to the outbreak of war, direction finding was an important activity of several wireless societies, notably of the Hendon and Golders Green Radio Society. Many amateurs had attained a high measure of skill, and anyone unable to take bearings within a margin of error not exceeding about two degrees stood a poor chance of winning a prize at the competitive field days that were organised periodically. It should be pointed out that this high order of accuracy was commonly obtained with relatively simple and inexpensive portable apparatus. In practice it has been found that with a fairly skilful operator and a well-made receiver bearings can be taken to within $\pm 1^\circ$, up to a range of about 15 miles on 40 metres, therefore any error greater than this must be due to either the transmitter position in relation to the receiver or the effect of the objects in the immediate vicinity of the receiver or to atmospheric conditions. All this goes to show that amateur direction finders are far from being toys, and that the subject is worthy of the attention of any-

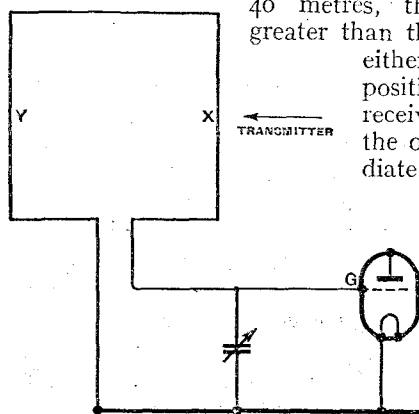

Fig. 1.—Explaining directional reception by means of a frame aerial.

Direction finding, in the form of the competitive field day, must obviously be shelved "for the duration," but there is no reason why this fascinating though somewhat neglected branch of amateur wireless should not still be pursued in a manner more suited to present conditions.



one who treats wireless as a serious hobby.

Dealing now with the actual direction finding receiver and associated equipment, it is assumed that a receiving set employing a loop or frame aerial will be used, therefore let us first briefly consider the theory of the directional properties of a loop. Referring to Fig. 1, assuming the frame to be of square section, a signal

from a transmitter lying in the same plane strikes the frame first at X then a fraction of a second later at Y. Then, if the dimensions of the frame are small in comparison with the signal wavelength, the voltages induced in opposite sides of the loop will be very nearly equal (the voltages induced in the horizontal portions will be zero and will have no effect on the circuit).

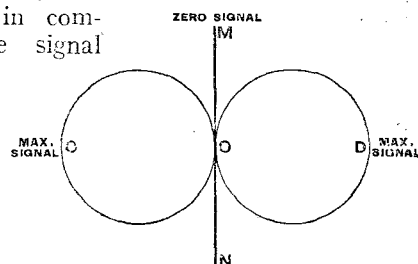

Fig. 2.—This "figure-of-eight" diagram represents the waxing and waning of signal strength that occurs as a frame is rotated through 360 degrees.

When the voltage induced by the signal wave is a maximum in X it will be slightly less in Y. It is the difference between the voltages at X and Y which causes a current to flow round the loop, thus producing a PD across grid and filament of the valve at G. If the frame is now rotated through 90° so that the

Amateur DF—

plane of X and Y are at right angles to the transmitter, the voltages induced in X and Y will be equal at any given moment and therefore no current will flow in the loop. If the frame is rotated a further 90° X and Y will again be in the same plane as the transmitter and current will flow, due to the difference of voltage, but as the wave will now strike Y before X the PD at G will be in the opposite phase. Rotating the frame through 360° the resultant PD at G may be plotted as the well-known figure-of-eight diagram, Fig. 2. It will be seen that the two points of minimum signal M and N are far more clearly defined than the points of maximum, hence the reason for always taking bearings on the minimum signal.

Unfortunately, the frame aerial as a whole acts as an ordinary aerial due to its capacity to earth; this pick-up effect is practically the same irrespective of the plane of the frame to the transmitter. This is known as "vertical effect." The voltage applied at G by the vertical component of the signal can be represented as in Fig. 3 by a circle AB with its centre at o.

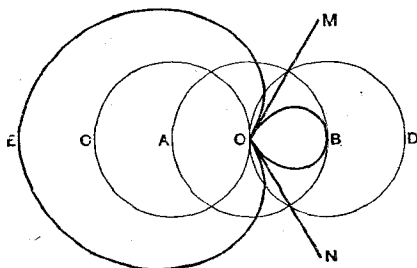

Fig. 3.—Polar diagram showing strength of signal received by a frame combined with the signal due to the action of the frame as a vertical aerial.

It will be realised that with the plane of the frame as in Fig. 1 the signal due to vertical effect may be in phase with, and therefore additive to, the signal received by the loop and can be shown as OE. When the frame is rotated through 180° the two signals will be out of phase and can be shown as OB. The result is that the minima M, O, N are distorted instead of being at 180° as in Fig. 2. Vertical effect also causes another trouble—that is, blunt or indefinite minima. It is possible to eliminate most of the vertical pick-up in frame aerials by connecting the centre tap to earth as in Fig. 4.

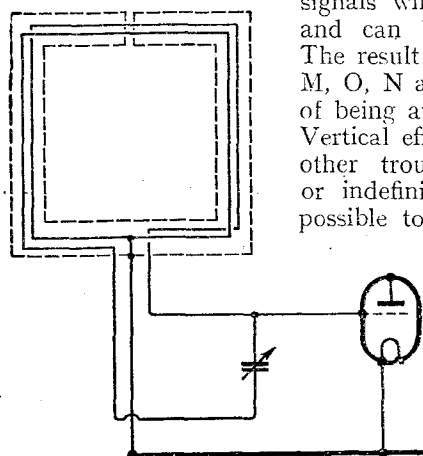

Fig. 4.—"Vertical effect," which gives rise to errors, is minimised by centre-tapping the frame and enclosing it in an almost complete screen.

screen earthed to the centre tap of the loop. It will be noticed that a gap is left at A to prevent the screen forming a closed loop.

Having taken the above precautions there will only be a very small amount of "vertical" to eliminate and this can be made use of to give a sense bearing, i.e., to show in which of the two possible directions the transmitter lies. If a small vertical rod aerial is coupled either to one side or the other of the frame aerial by means of a small differential condenser, as in Fig. 5, a little of the vertical component of the signal may be deliberately introduced in such a way, say, that it is in phase at one minimum position with the "vertical" signal due to the loop itself. This will cause an indefinite minimum, but if the frame is now rotated through 180° degrees the injected signal from the "open" aerial will be out of phase with the loop signal and a sharp minimum will be obtainable. Instead of rotating the frame the differential condenser can be adjusted so that the vertical aerial is coupled to the other leg of the loop; again, only one sharp minimum will be obtainable on a transmission.

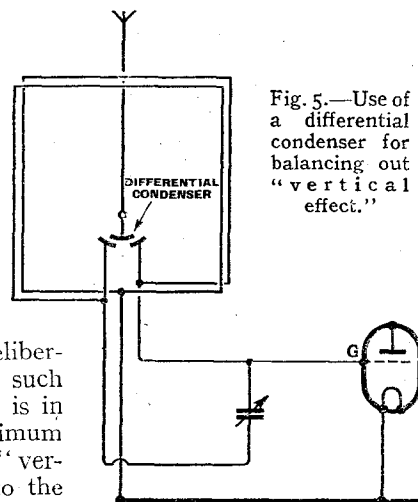
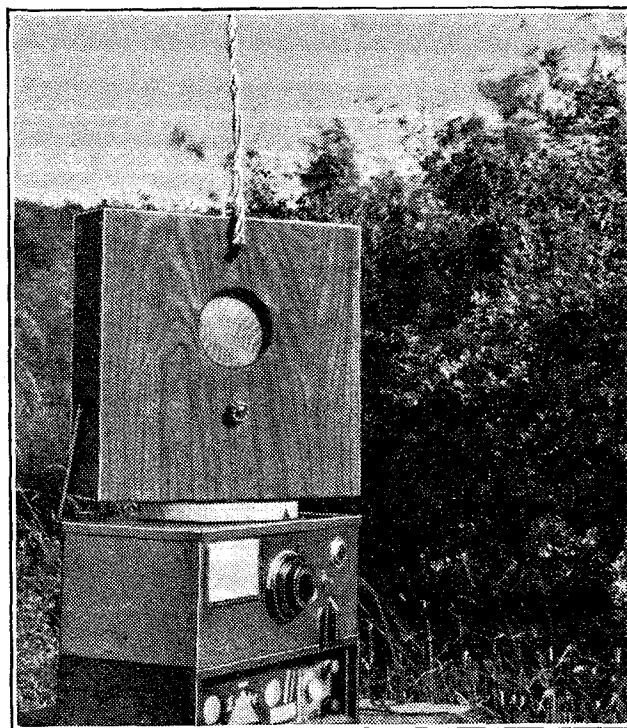

Fig. 5.—Use of a differential condenser for balancing out "vertical effect."



The author's DF unit. Note the loud speaker in the centre of the frame.

Amateur DF—

Various types of receiving sets were used in the early days of amateur DF, but probably the most popular circuit was the Reinartz or Hartley detector followed by one or two stages of AF amplification; very little was done in the way of screening. Results, however, tended to be erratic as, owing to an oscillating frame aerial, body effects were troublesome and minima were indefinite and unreliable. Great improvements were effected by completely screening the receiver in metal and taking precautions to prevent direct signal pick-up on the headphone and battery leads. A further improvement was made by using an RF stage coupled to the detector by a tuned anode or tuned grid circuit, reaction being obtained by variable capacity coupling to the coil. The frame aerial now being non-radiating, some of the body effects were eliminated.

A Practical Design

A typical circuit for an amateur direction finder is shown at Fig. 6. It will be seen that the frame has an earthed centre tap and a small vertical aerial is coupled by a differential condenser to either end of the frame winding. The tuning condenser must, of course, be insulated from chassis when mounting. The grid leak of the detector valve is taken to a potentiometer across the filaments so that adjustment can be made for smooth reaction, which is always desirable, particularly if the set is used in an oscillating condition for taking bearings of CW stations. The detector valve may be followed by one or two stages of AF amplification. The author prefers two stages as shown; when dealing with a minimum signal for taking bearings it is a great advantage to have plenty of magnification.

and up again to R7 with no definite dip in volume to identify the minimum position of the frame. The only thing to do under these circumstances was to swing the frame backwards and forwards over the minimum and

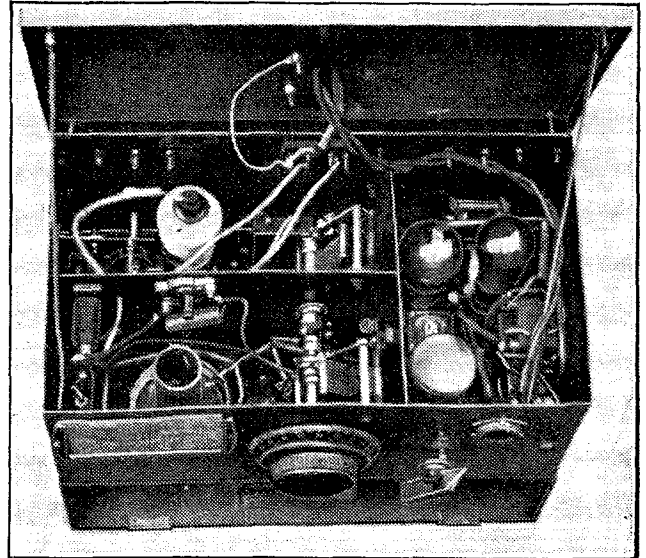

Careful screening, as in the author's set shown here, is absolutely essential in DF work

note a position on either side on which the signal appeared to be the same volume and then take the mean position as minimum. As can be readily understood, it was very much guesswork and sometimes it was impossible to get nearer than $\pm 10^\circ$, at other times, however, it would be easy to get the signal to completely dis-

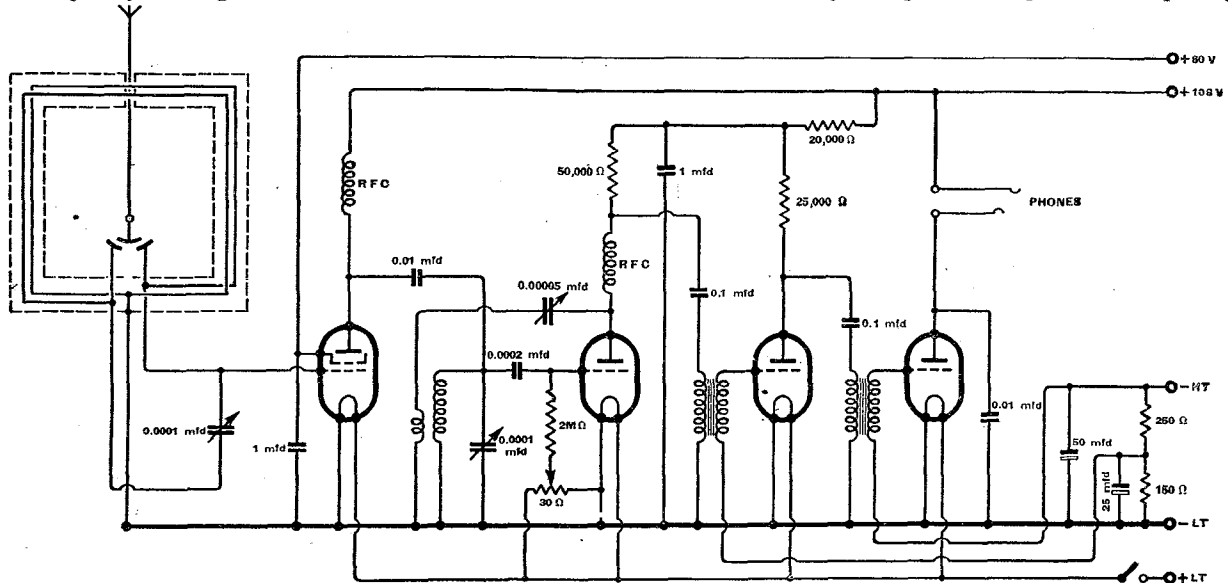

Fig. 6.—Complete circuit diagram of the author's receiver.

In the early days of DF the problem of indefinite minima was always a worry; on some occasions, as the frame was turned through 180° , the change in volume on headphones would vary from, say, R7 down to R2,

appear over about 1° . The author found that a compass scale fitted to the frame was a great help, as it was possible to re-check a bearing or see if the reciprocal bearing, i.e., the frame turned through 180° , coin-

Amateur DF—

cided. The cause of the indefinite minima obtained was puzzling at first, as a receiver might be in one position for, say, four different transmitter positions and the sharpness or otherwise of minima obtained would vary greatly. It was found that the vertical component of the signal wave could vary during the day and that different transmitter positions also caused a variation. Fitting a small vertical aerial as shown in the circuit overcame this trouble.

For 40 metres, four turns on a 10in. square is suitable for the frame, with a spacing of $\frac{3}{16}$ in. between each turn. The author prefers a wooden box type frame, as it is mechanically rigid and protects the winding. When winding the aerial great care must be taken to see that the wires are taut and that the plane of each turn is parallel to the side of the frame case. The electrostatic screen should be at least $1\frac{1}{4}$ in. away from the winding of the frame. The screen can be made of copper foil bent into channel section approximately 3in. wide with $1\frac{1}{4}$ in. sides; the gap at the top need only be about $\frac{1}{8}$ in. The frame itself can be made of $\frac{1}{2}$ in. wood, outside dimensions being 14in. square by 4in. The copper foil screen is fixed by drawing pins. To the bottom of the frame is fixed a piece of wood $7\frac{1}{2}$ in. in diameter $\frac{3}{4}$ in. wide, which is marked out 0.360; a pointer is fixed to the lid of the set.

The set itself is completely enclosed in a copper box with the battery compartment below. It is important that the wires connecting each end of the loop to the set are individually run in screened tubing, earthed, or something similar, in order not to upset the tuning whilst swinging the frame. Similarly, if a loud speaker is fitted in the centre of the frame as in the writer's set, the leads to it must be screened.

It is hoped to deal in a subsequent article with the best way of operating the set and taking bearings.

Home-made Morse Recorder

THIS apparatus, made by Mr. Cecil H. L. Andrew, will record signals from any radio receiver of reasonable output at any speed up to 80 words per minute, the only limiting factor being the prevailing noise level. It is composed of a gramophone induction motor (shown on the right) which has two adapted rubber rollers to act as a tape puller. The magnet of the "writer" in this case is an old mains-energised field coil, although a permanent magnet could be used. The magnet face plate is turned down to give extra space, and working in this is a cardboard coil former wound with 500 turns or less of No. 42 enamelled wire. Connected to this is a pivoted lever operating a pen made of thin brass tubing connected by a very thin rubber tube to the ink-well, made of an old glass syringe body. The moving coil must be matched by a suitable transformer to the optimum load of the output valve. Interposed between transformer and coil is a Westinghouse rectifier, Type LB13. The ink used is made from methylene-blue $\frac{1}{4}$ oz.; hot distilled water 1 pint, 20 per cent.

methylated spirits, filtered. Key to photograph: N, induction motor; S, speed regulator; D, paper drum; T, transformer; R, rectifier; C, moving coil; P, pen; M, magnet and field coil; I, ink-well.

Henry Farrad's Problem Corner

No. 48.—A Question of Current

An extract from Henry Farrad's correspondence, published to give readers an opportunity of testing their own powers of deduction:—

Howell House,

Keston.

Dear Henry,

Here is another little problem to bother you with. I drive my receiver by an entirely conventional type of power unit, as you can see from the diagram. The only special feature is that I have fitted jacks for measuring

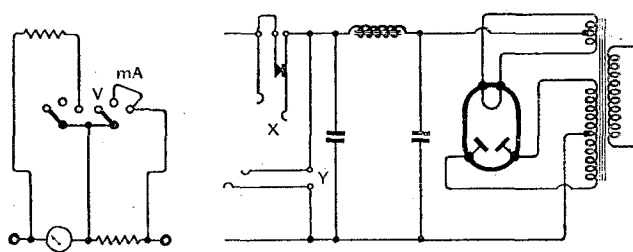

the output current and voltage. The current-measuring jack X is of the type that short-circuits itself when the meter is unplugged; the other, Y, naturally is not.

The real reason for fitting these jacks is a burst of enthusiasm resulting from the construction by me of a combined volt-milliamp meter using a 0.1 mA instrument. When the switch is in one position there is a high series resistance, giving a range of 0.500 volts; in the other, this resistance is shorted and a shunt is connected, giving a range of 0.100 mA. There is also a switch position without the shunt, giving the original 0.1 mA range.

The trouble is that recently the current taken by the receiver has been increasing to a varying extent. I have examined everything in the receiver, and no explanation of this increased current is forthcoming. The voltage, by the way, is perfectly normal. Can you suggest anything?

Yours gratefully in anticipation,

PHILIP COWE.

(Henry Farrad's solution is on p. 326.)

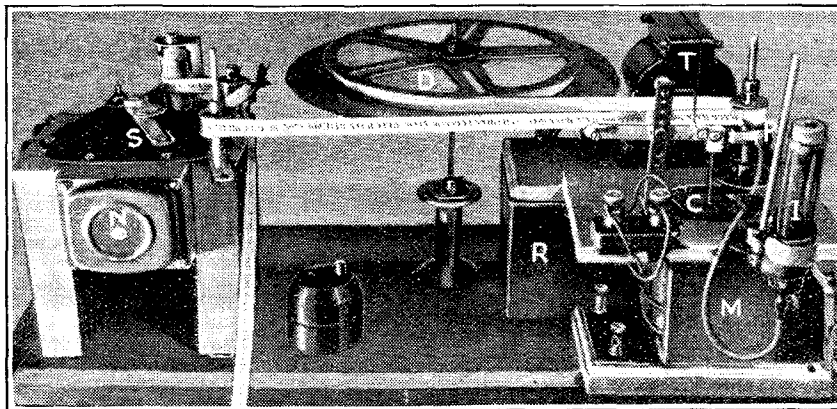

Principles of Fault-tracing

Part II.—APPLYING BASIC IDEAS TO SPECIFIC CASES

By W. H. CAZALY

IN last month's instalment so much time was spent in stressing the need for logical methods in fault-tracing that we got no farther than establishing the goodness of the primary mains circuit of the receiver under discussion, the circuit diagram of which was given in Fig. 1 last month. We can now proceed at greater speed. The next step taken by a methodical fault tracer would probably be to test for a S/C (short-circuit) between HT + and chassis. He would do this before plugging the mains lead into the nearest mains point, because if a S/C did exist, the ruin of the receiver by a burnt-out mains transformer or stripped rectifier valve might be completed during the time the set was running with a S/C across HT and chassis while the tester was preparing his meter and leads for work.

Now a little thought will show that the complete silencing of the receiver by a S/C could be brought about by S/Cs only in two places: across both L₂ and L₃, and across C₁. If S/Cs occurred in any part of the circuit on the aerial side of the speaker field winding L₄ they would not stop current flowing in this winding, and this current would give rise at least to residual hum in the speaker. C₁, L₂ and L₃ can be tested for S/C very easily through the rectifier valve-holder sockets. (References are to Fig. 1, last month's issue.)

Step-by-step Tests

If, as in the present case, no S/Cs were shown on the meter, the next step would probably be to plug into the mains point, switch on the receiver, and test for positive potentials at such convenient points as valve-holder sockets and soldering lug terminals on the speaker field and output transformer. A moment's thought will show that O/Cs could cause complete silence if they occurred only in three places. These places are (1) L₂ and L₃; (2) LT supply windings, and (3) L₄, the speaker field. Again an eliminative process can be easily carried out by simple continuity tests. This would reveal L₄ as the defective part of the circuit.

Assuming for the sake of illustration that L₄ were found intact, there would remain only one possibility—that L₅ or L₆ were O/C. The investigation of these possibilities would probably be left to the last because they demand the dismantling of the speaker and its accessories in the majority of sets.

The preceding may seem a long-winded description of what is a very elementary example of fault-finding. It is valuable, however, on two accounts. First, it shows that by logical deduction it is possible to avoid wasting time (which is usually money in commercial servicing) in making unnecessary tests. Secondly, it has demonstrated the applications of a fundamental aphorism and a basic rule in all fault-tracing.

The aphorism may be stated thus: "Any defect is either a short-circuit, or an open-circuit, or a functional maladjustment." The rule is as follows: "Select the minimum number of possibilities that would account for the appearance of the symptoms and then eliminate them one after the other by direct experimental test."

In the opening instalment the author discussed the general principles of fault-tracing, and stressed the need for logical and systematic procedure. He now goes on to deal with the location of specific faults, such as "no signal," weak signal and distortion.

These may seem truisms, but that is only because they are so constantly and inevitably applicable in fault-tracing that they are taken for granted. Their value becomes apparent as soon as they are neglected, as any inexperienced fault-tracer will speedily find out.

Now that the basic ideas in fault-tracing have been set out, it will be interesting to see how they can be applied to special cases. To review the process—the symptoms suggest the general line of approach to the problem, the aphorism states in general terms what has to be looked for, and the rule suggests how to do it.

Symptom No. 2, "no signal," is one, again, the cause of which is usually quite easy to find. By "no signal" is meant a condition in which residual field hum is heard in the speaker, but apparently no signals derived from aerial pick-up are transferred through the set to the speech coil. The first and most obvious conclusion is that at some stage in the circuit, the signal is being either by-passed straight to earth or chassis, or is not being handed on by some coupling or amplifying device to the following stage. The solution of the problem therefore divides into two parts, of which the first is to find at what stage the loss of signal is occurring, and the second is to find which of the components comprising this stage is at fault.

The first part of the solution may be done, often, during the preliminary tests for anode voltages, goodness of valves, etc. For example, when putting the test lead of the meter on valve anodes for voltage checking, clicks will be heard in the speaker (or, perhaps, the howling of instability provoked) if the circuit subsequent to the point tests is in order, so far as the conveying of simple current or voltage disturbances is con-

Principles of Fault-tracing—

cerned. To make the point clear: if, in Fig. 1 of last month's instalment, a click is heard when the anode of V₂ is touched by the test lead of the meter, but no click is heard when the anode of V₁ is touched, plainly the coupling between these two valves is defective. Having thus confined the probable area of the fault, it remains to list the possibilities of defect in this area and then to eliminate them by direct test, one by one. There are, it must be remembered, only S/Cs, O/Cs and maladjustments to be thought of. One possibility of the first nature is contact between the two plates of the trimmer condenser across L₁₄. A possibility of the second nature is that R₁₀, the screening grid feed resistor of V₂, is O/C. The only maladjustment possible is that of the trimmer condenser of T₅, i.e., the IF tuning may be very badly out.

Already it may have become clear that fault-finding, which is 80 per cent. of radio repairing, is one of the things that can be studied "on paper." This is, of course, contrary to the cherished beliefs of "practical men" who are rather regrettably under the impression that theoretical knowledge is of little use to anybody but "highbrows." It should be obvious, however, that a man who is able to perceive the interactions of electrical effects from paper diagrams is likely to deduce the location of a defect much more readily and quickly than the man who prods blindly about looking for something he can grip with pliers. There is so much in radio that cannot be gripped with pliers.

The above may explain something of what may be going on in the mind of a fault-finder engaged with a receiver exhibiting Symptom No. 2. While examining the aerial, he would be listening to hear if its removal and replacement caused clicks in the speaker. While checking anode voltages, he would again be listening for clicks. If he found all voltages present and correct and clicks at each tested point, he would suspect, offhand, a maladjustment of tuned circuits, especially those of the local oscillator section.

This is a convenient point at which to mention test

for a few shillings. Even in this elementary form they have the advantage over broadcast transmissions in that they can be used at any time and at any frequency. There is a good deal of literature about them, and they are mentioned here only in connection with maladjusted tuned circuits. Their signal, fed into RF or IF stages, replaces the "click test," which is only good enough to test the general continuity of transference of signal through the set. They are practically essential for the correct adjustment of tuned circuits in superheterodyne reception, a subject that has been helpfully treated in *The Wireless World* on more than one occasion.¹

Lack of Sensitivity

The search for the cause of Symptom No. 3, "weak signal," may involve the use not only of a reliable test oscillator, but also of an output meter. This is a vague sort of symptom, rather like the "pain in my tummy" of the doctor's child patient. What seems a weak signal to one person may be a deafening row to another. For this reason, professional fault-finders prefer to have definite standards based on instrument readings against which they can compare performances of the receivers they have to deal with. Even in the quiet of a set-owner's home, the intensity of the sound output of the speaker is a difficult thing to judge accurately by ear alone. Another name for "weak signal" is "lack of sensitivity." The term sensitivity then has to be defined. Putting it in very general terms, the sensitivity of a receiver is a measure of the voltage that must be developed across the aerial and earth terminals in order to obtain a standard output from the output stage. The standard output is usually taken as 50 milliwatts of AF power developed in the anode circuit of the output valve or valves. To obtain this output, so many microvolts, modulated at such and such a frequency to a given depth—usually 400 c/s, 30 per cent. depth—must be put into the aerial-earth terminals. Thus a powerful communication receiver may be said to have a sensitivity of the order of two or three microvolts, while a simple detector-two-AF set

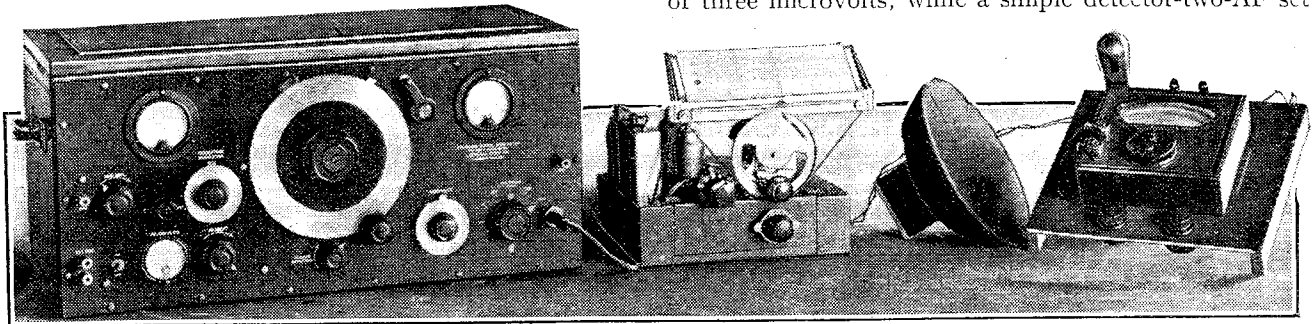

Set-up for checking sensitivity, alignment, etc. A modulated test oscillator or signal generator is practically indispensable in professional servicing. Some operations cannot be performed without it, and in other cases it saves hours of laborious direct testing of components. It may be home-built for a few pounds or be bought for anything up to two hundred guineas.

oscillators—which rise in the social scale and become "signal generators" if they cost more than a few pounds and are fairly accurate. In their simplest form they consist of little more than a one-valve reacting receiver made to oscillate and which can be home-built

may have a sensitivity of 1 volt. Hence, before it is possible objectively to decide that the sensitivity of a set is below normal, one must know what its normal

¹ "Superhet Alignment." *The Wireless World*, June 16th and June 23rd, 1938.

Principles of Fault-tracing—

sensitivity is, in terms of volts or millivolts input to the aerial-earth terminals for a given, say, 50 milliwatts, output. Knowing this, it is possible to check the sensitivity of a set with a calibrated output meter in the anode circuit of the last valve and a calibrated attenuator controlling the output of a test oscillator feeding the aerial-earth terminals.

Not many people care to go to the trouble and expense of such testing for sensitivity. They use their ears as output meters and the more distant broadcast stations as sources of test signal, with the result that they seldom notice any falling off in sensitivity until it becomes so obvious that it points to some gross breakdown in the receiver, and is accompanied by some other symptom such as noise or distortion. In such forms it is not difficult to trace its causes. It is rare for signals to be merely weak and neither distorted nor accompanied by noise, unless a general, overall deterioration of the set has taken place—valves past their prime, components worked to their limit of safe load going slightly below par. This is very often the case when an elderly or at least ripely middle-aged receiver begins to dissatisfy the family and is not rejuvenated even by new valves. If a very thorough examination were made of all the components of such a receiver and its aerial-earth system, small departures from optimum values would be found in the constants of a number of components. Together, they would give rise to overall fall in sensitivity and signal-noise ratio. It is possible, however, for the deterioration to be somewhat localised around one stage or another. This is where the calibrated test oscillator and output meter come in.

A Standard of Comparison

Much can be done even with a very simple oscillator and an uncalibrated output meter if access can be had to another receiver of the same make and type and known to be in good order. Then the gains obtained at each stage can be compared and the weak stage thus found. The manufacturer's service-man has the advantage over the set owner or local service-man in this matter in that he has a large number of exactly similar receivers to deal with and is able to make a table of the gains he expects to get from each stage. He can set his oscillator output attenuator knob, for example, to a certain figure for the IF, and if, on feeding this signal into, say, the primary of the second IF transformer, he does not get an expected deflection on his output meter, he knows that a least the fault lies in the circuit towards the speaker end and probably not towards the aerial end. So he can test each stage individually by these comparative methods, without expensively calibrated apparatus, until he finds the stage at which lack of gain is occurring.

To sum up a rather inconclusive dissertation it may be said that the symptom "weak signal" really means "loss of sensitivity," and that, as usual, the first step is to find out at what stage normal gain is not being obtained. This can only be found by actually feeding a signal into that stage and measuring the resulting output. This in turn implies a standard input and a standard output. If these standards are unknown or ignored, the affair becomes a rather crude hit-and-miss attempt to get the loudest possible sound out of the speaker for any convenient form of input signal and estimating very roughly by ear whether or not a stage is doing its bit towards that loudness. This is the method beloved by the majority of present-day service-men and set owners.

Distorted signal, Symptom No. 4, is another comparative fault involving subjective factors which are extremely hard to analyse. As a matter of fact, some form of distortion is usually introduced deliberately into the reproduction of commercial domestic receivers to make them acceptable to the public, and not only would a conscientious radio engineer find it extremely expensive and laborious to remove these distorting

factors from the performance of the average home radio receiver, but when he had done so, he would probably be accused of having "ruined the tone" of the set by the annoyed owners. In the matter, indeed, of distortion the adage about one man's pick-me-up being another's allergic is so true that, strictly speaking, distortion is merely part of the vast subject of realistic reproduction with which we are here only indirectly concerned.

But there are certain forms of distortion that everybody finds intolerable. These may be classified under the two heads of (1) resonance effects, and (2) disagreeable alteration of wave-form. Each class of such distortion may be due to either (a) electrical or (b) mechanical properties of receiver parts. As an example of (1) there is the orchestral piece in which one particular note, each time it sounds, has a piercing quality making it stand out from the rest of the sound pattern; this effect may be due to either (a) some peculiarity of an inductive circuit giving excessive amplification at that frequency, or (b) some property of the speaker cone, or of the cabinet in which the speaker is housed, or even some acoustic peculiarity of the room or hall in which the speaker is sounding. As an example of (2) there is the harsh reproduction that occurs when the HT battery of a Q.P.P. output receiver is running down or when the speech coil is badly centred.

Cause and Effect

Now it is very seldom easy to distinguish certainly between the effects produced by these widely differing types of fault. The list of possibilities is bound therefore to be rather large. Elimination of each possibility,

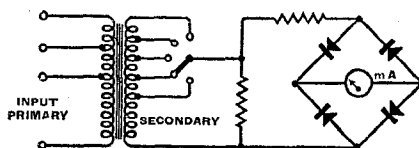

Fig. 2.—Essential circuit of an output meter. By taps on the primary and secondary of the transformer, the instrument may be matched to various valve and line impedances. The meter itself may be simply an AC voltmeter connected externally, if only comparative readings are required. If permanently incorporated, the meter may be calibrated in volts or milliwatts with a permanent load resistance across the secondary.

Principles of Fault-tracing—

however, in turn, is not so difficult. A number of them will be disposed of during the preliminary basic checks of voltage, etc. It must be borne in mind during these checks that single tests can often form the starting points of quite long chains of reasoning. The fault-finder's mind must therefore be constantly on the alert for clues as he works. For example, if the anode voltage of V₃, the double-diode-triode in Fig. 1, were found abnormally low, at least three possibilities could exist: (a) R₂ might have "gone high;" (b) C₄ might be S/C; (c) C₅ might be S/C. Any one of these would by itself account for the distortion of the signal. All could be easily checked through the valve-holder sockets—the elimination process. If the anode voltage, on the other hand, were found abnormally high, the reasoning would be thus: high voltage at the anode means small voltage drop through R₂—which means small anode current through V₃—which means either loss of emission of V₃ or excessive negative bias on the grid—which latter means that R₆ has gone high. . . This is the kind of thinking that must be going on continually in the fault-finder's mind; it is very hard work.

Speaker Tests

However, if the preliminary tests have revealed no abnormality, it will be as well to make sure next that the speaker is in good order. Undoubtedly the best way of doing this is to connect a test speaker in place of the set speaker. If the distortion occurs only when the volume is turned to maximum and the output is such at that level that a pretty hefty speaker is needed to handle it without trouble, a good scheme for making use of a small, cheap speaker is to use a good attenuator for feeding the output to the small test speaker: *The Wireless World* Diary gives on page 73 a useful attenuator "volume control" circuit that might be used for this purpose. If, however, the speaker is found not to be the source of distortion, there remain two courses open. One is to trace the signal as it goes through the receiver from stage to stage, and try to pin down the stage at which distortion is occurring.

This involves the use of some device for listening to the signal in AF form at each stage, and the use of almost any such device will introduce factors into circuit conditions that will seriously upset performance. Thus, to pick up the signal in the HF or IF stages, a metal or diode rectifier—"detector"—must be used, coupled by inductive or capacitive means to those circuits; this will mistune those circuits or cause insta-

bility without laborious precautions. In the AF stages, placing 'phones across load impedances will again upset performance, unless some valve-input device is employed to feed the 'phones. Almost as cumbersome a method is to provide a special modulated signal to feed into each stage in turn: this special signal must itself be above suspicion as regards distortion and it must be made suitable in intensity and output impedance for the stage to which it is to be fed.

Accessory Circuits

On the whole, it will probably be more convenient to go through with an eliminative process by direct test of components. This need not be so laborious, after all. If anode voltages and currents are found to be in order—anode current usually tells a long tale—the fault must plainly be in some accessory circuit, such as the AVC network which is quiescent unless the receiver is handling a signal. If definite data can be obtained relative to the AVC voltages to be expected for given signal carrier strengths, these voltages can be directly checked up by measurement with a valve-voltmeter. But if they are not obtainable, the components making up these networks must be individually tested. (AVC networks only are mentioned; but the principles apply to all accessory circuits, such as ATC, negative feed-back, etc.)

Here it is necessary to digress in order to deal with certain practical difficulties that may arise in testing these accessory circuits. It is all very fine to say "Test the components . . ." on paper, but in practice, the fault-finder may discover that it is not so easy to measure high resistances, low capacities, and voltages developed across circuits of such high impedance that bridging them with anything else but a valve-voltmeter completely upsets them. It is easy to measure high resistance directly with a 500-volt megger,² or small capacity with a bridge,² but these instruments are normally rather expensive and hardly justified as stock in small workshops. It is possible, however, to use a valve circuit which is cheap and simple to make up and which gives readings of sufficient accuracy for fault-tracing. An instrument of this type will be described in the next instalment; in addition to its uses in checking resistances, it provides for measurement of various AC and DC voltages, and inductance and capacity measurements.

² An inexpensive but reliable bridge for resistance and capacity measurements was described in *The Wireless World*, for June 16th, 1938.

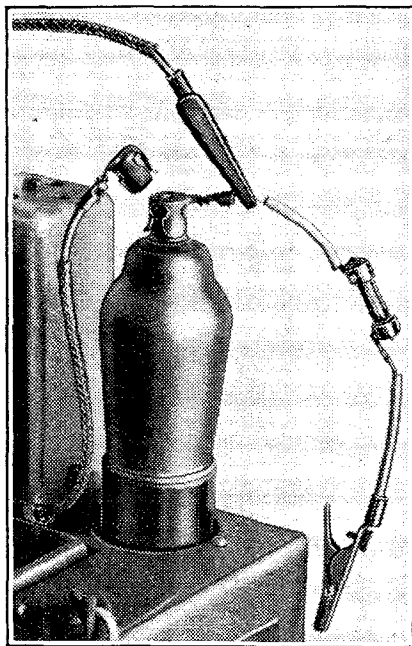

Checking for sensitivity, IF tuning, etc. The clip is removed from the top grid connection of the frequency-changer and replaced by a temporary arrangement connecting the grid to chassis through a 0.25-megohm resistance. This avoids leaving the grid "free" while the signal from a test oscillator is applied to the grid. If AVC is to operate on the frequency-changer, the earthy end of the resistor must be taken, not to chassis, but to the normal source of AVC voltage for this valve.

Unbiased

By FREE GRID

Realism Run Riot

I DON'T think that the most biased person among you could ever accuse me of having been on terms of undue cordiality with the B.B.C. at any time during my career. This is largely due, I think, to the fact that I have a certain amount of Scottish blood in my veins, having once been the grateful recipient of a transfusion from a Highlander when in a very low state

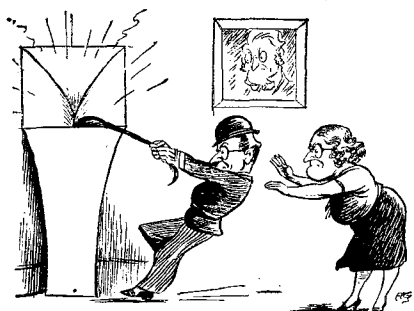

A firm grip on its tail.

after listening to a chamber music concert. Like all people of Scottish extraction, I believe in getting my full ten shillings-worth of value for, after all, in spite of the arguments of the purists to the effect that the ten shilling licence is a tax and not payment for entertainment, the B.B.C.'s income is inextricably bound up with the number of licences issued, and fluctuates with it.

At any rate, whatever be the source of my feeling of antipathy to the B.B.C. and all its works, this feeling has, as the result of one of their recent broadcasts, now widened into an open breach. I refer to the broadcast which they gave recently of the singing of the nightingale, when the wandering microphone took us from wood to wood in the stilly watches of the night. As a result of their efforts, I find myself faced with a bill for a new loud speaker, and the possibility of a police court charge at the instance of

one of the animal protection societies.

My house, like that of any other real wireless fan, has, of course, each room equipped with a first-class loud speaker, every one of which has had to be designed and built by myself to suit the acoustic properties of the particular room in which it is used. This fact, coupled with the extraordinary realism of this particular B.B.C. broadcast, is the cause of all my present troubles, as, at the time of the nightingale broadcast, one of Mrs. Free Grid's innumerable feline friends (four-legged variety), which uses my house as an hotel to eat and sleep in the intervals between its nocturnal wanderings, happened to be the sole occupant of a room which contained one of my most successful exponential horn designs.

The result was that as soon as the nightingales piped up the cat took it as an invitation to a gargantuan feast, and took a headlong dive into the horn, where it promptly became stuck, and its howls of dismay quickly brought Mrs. Free Grid and myself on the scene. Unfortunately, the horn was of the vertical type, and the force of gravity, coupled with the cat's struggles, only served to wedge it more firmly in. All my efforts to extract it by a firm grip on its tail merely made matters worse, and its howls of indignation, coupled with those of Mrs. Free Grid, caused a perambulating policeman to appear on the scene.

In the end, the loud speaker horn had to be demolished with an axe and, apart from having to expend considerable time and labour in replacing it, to say nothing of the cost of materials, I find myself liable to be hauled up before a court of so-called justice on a charge of cruelty to animals. The only bright spot in the whole sorry business is that this incident once and for all disposes of the old canard about the B.B.C. using gramophone records for these nightingale broadcasts; it

was far too realistic for that, for no cat can be deceived by a gramophone record, as I have since proved by experiment.

Things to Come?

ONE day many years ago, when journeying across the desert, whither I had gone in order to test out a patent Chemical Wireless Earth for the Editor of this journal, I was invited home by an aged Eastern Seer who regaled me with a sumptuous repast of hashish served by an army of houris.

I speedily found out that the sole reason for this lavish hospitality was that he was a reader of *The Wireless World* and was in trouble with a crystal set which he had constructed. In return for my help he gazed into his crystal and warned me that ere



An aged Eastern Seer.

long a dark and ominous shadow would cross my path, and although I laughed this prophecy off it was only a few weeks later that Mrs. Free Grid first loomed up menacingly over the horizon of my life.

He has now sent me the mystifying message to "make ready the magic mirror, for ere long it will shine forth once again." I wonder if any of you pukka sahibs who have lived out East can tell me what he means. Perhaps you may be able to recognise him from the accompanying photograph.

Letters to the Editor

THE EDITOR DOES NOT NECESSARILY ENDORSE THE OPINIONS OF HIS CORRESPONDENTS

Broadcast Receivers for a Blitzkrieg

SPEAKING from recent experience of difficult active service conditions in the field, I should like to give my views of the requirements of radio for overseas troops. Sets may be divided into two main classes: those required to entertain comparatively large bodies of men—say, up to 70 or 80—in barns and similar billets; and those required by smaller bodies and by units strenuously engaged in field work. The first type of set should be a modification of "car radio"—i.e., a sensitive set using mains-type valves and deriving its power from a vibratory HT unit which can be plugged in to the nearest lorry or car accumulator: It is possible for the complete car-radio outfit to be housed in a simple wooden structure with a carrying handle, but the vibratory unit must then be very thoroughly screened and a screened cable well earthed should be used to connect with the car battery. Such a system gives plenty of output without the troubles arising from dry HT batteries. The second type *must* derive its LT and HT from dry cells; accumulator charging is usually almost impossible.

Frame-aerial portables are not advisable, unless they are of the "transportable" superhet type and very strongly constructed with facilities for wedging the accumulator and HTB firmly in position. Nor are straight sets with reaction at all suitable, as oscillation is liable to give away one's position to the enemy—even if such sets are sensitive enough to pick up English broadcasts. For individuals or very small groups of a few enthusiasts, headphones can be used, saving the power and space and weight required for speaker operation.

Aerials and earths present no difficulties—an iron spike in wetted ground for an earth, and a well-insulated cable flung over a tree or roof-top for aerial, are far better than frame aerials, and a minor trouble to fix under field conditions. The whole subject bristles with problems which will not be solved as simply as those with no active service experience may imagine.

"TIFFEY."

"Constant Potential Rectification"

IN your June issue, your correspondent "Ich Dien" has endeavoured to carry the comparison of the relative ease of smoothing of normal single-phase rectifiers and "Westat" and "Noregg" rectifiers a stage further. In doing so, he has assumed that the smoothed constant potential output is required only for communication systems, and although this application is admittedly important, it does not by any means constitute the whole field of application.

For many other applications, which are perhaps of more interest to readers of *The Wireless World*, the relative "ease of smoothing" ratio given in the article will hold good.

As regards the particular application to telephone

communication systems, while it is of course true that the residual ripple after smoothing should be judged on a basis of reduction in articulation efficiency caused in such a system, it then becomes essential to consider the full harmonic content of the ripple. This point has been overlooked by "Ich Dien," who has incorrectly assumed the output ripple of a single-phase rectifier to be entirely at a frequency of 100 c/s, and that of a three-phase bridge rectifier to be entirely at a frequency of 300 c/s. An analysis of these wave-forms will show that the single-phase rectifier ripple is very rich in higher harmonics, and further, that the harmonics at 300 and 600 c/s are, in fact, exactly equal to the two largest ripple components of the output of a three-phase rectifier, which occur at these frequencies. The apparent disadvantage of the three-phase rectifier is therefore actually non-existent.

Your correspondent further argues that since the ripple output of a "Noregg" or "Westat" rectifier varies progressively with load changes, the filter must be designed to deal with the worst condition, and that little advantage can therefore be taken of the low ripple which occurs when the rectifier is fully loaded. Fortunately, this apparent difficulty is easily overcome by suitable design of the inductance elements of the filter, so that the filter has the maximum effectiveness toward light loads when the rectifier ripple is greatest, and is gradually reduced in effectiveness as the load is increased and the rectifier ripple decreases. By this means it is possible to effect a considerable saving in the cost of the filter.

S. A. STEVENS.

A. H. B. WALKER.

Morse Recording

WITH reference to the morse inker described in the March issue of *The Wireless World* I would like to add that morse signals can be recorded direct from

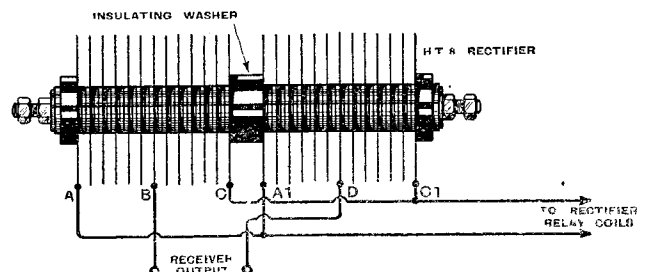
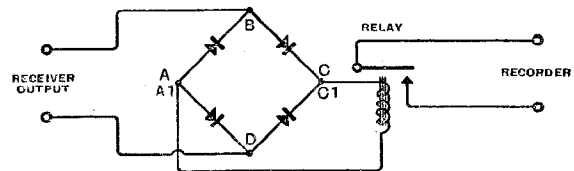

a wireless receiver by adding another old-type G.P.O. glass topped-relay into which the output of the receiver

Letters to the Editor—

is fed by means of a full wave rectifier. A Westinghouse type HT8 can be adapted for this purpose by slipping off half of the elements and fitting an insulating washer.

To test, the rectifier unit is connected to the recorder and receiver, the latter being tuned to a good strong signal. The rectifier relay contacts are then adjusted and simultaneously the receiver volume control decreased until the relay armature is working nicely on quite a small signal.

K. J. SALMON

(Technical Dept., Alexander Black, Ltd.)
London, S.W.1.

I HAVE been experimenting for several years on paper tape machines, and perhaps the following details would assist *Wireless World* readers who are working on this type of instrument. In the place of messy inks, and very careful adjustments of stylus, which is necessary in this type of instrument, I have used for some time a small "V" wheel in conjunction with a black typewriter ribbon. A message can be recorded by hand

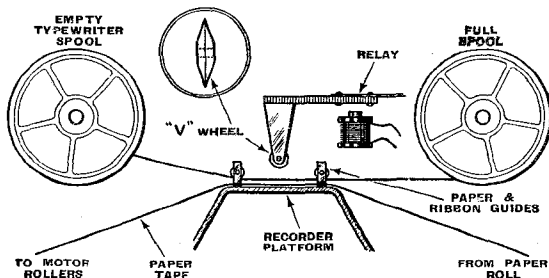

keying or from an R6 signal received on a 2-valve short-wave set.

Wireless Operator,
H.M.T. Lacemnia.

F. W. SMITH.

Dynatron Oscillator

I SHOULD like to get into touch with any reader who has constructed the AF Dynatron Oscillator described by M. G. Scroggie in his "Radio Laboratory Handbook," and who has modified the design for a larger output stage with negative feed back. J. POTTER

27, Kingsfield Drive,
Didsbury, Manchester, 20.

From the World's Journals

THE increasing difficulty of obtaining journals from abroad in the present circumstances has considerably enhanced the value of the Abstracts and References section of our sister journal, *The Wireless Engineer*. In the current issue, which was published on the 1st of the month, some 400 articles on wireless and allied subjects which have recently appeared in the technical journals of the world are abstracted or referred to. Another monthly feature is the summary of nearly 50 recently accepted wireless patent specifications.

In addition to these regular features, the June issue, which is obtainable through newsagents or direct from the Publishers, Dorset House, Stamford Street, London, S.E.1, at 2s. 8d. post free, contains articles describing a means of determining the residual parameters of variable air condensers, and electro-acoustic reactions, with special reference to quartz crystal vibrators.

BOOKS ON WIRELESS

Issued in conjunction with "The Wireless World"

	Net Price	By Post
"FOUNDATIONS OF WIRELESS," by A. L. M. Sowerby. Second Edition	5/-	5/5
"RADIO LABORATORY HANDBOOK," by M. G. Scroggie	8/6	9/-
"WIRELESS SERVICING MANUAL," by W. T. Cocking. Fifth Edition	5/-	5/5
"HANDBOOK OF TECHNICAL INSTRUCTION FOR WIRELESS TELEGRAPHISTS," by H. M. Dowsett. Sixth Edition	21/-	21/9
"WIRELESS DIRECTION FINDING," by R. Keen. Third Edition	25/-	25/9
"RADIO DATA CHARTS," by R. T. Beatty. Second Edition	4/6	4/10
"ELEMENTARY PRINCIPLES OF WIRELESS TELEGRAPHY AND TELEPHONY," by R. D. Bangay. Revised by O. F. Brown. Third Edition	7/6	8/-
"TELEVISION RECEIVING EQUIPMENT," by W. T. Cocking	7/6	8/-
"RADIO INTERFERENCE SUPPRESSION," by Gordon W. Ingram	5/-	5/3
"LEARNING MORSE"	6d.	7d.

Obtainable from Leading Booksellers and Railway Bookstalls or by post (remittance with order) from

ILIFFE & SONS LTD., Dorset House, Stamford Street, London, S.E.1

Henry Farrad's Solution

(See page 319)

A VARYING output current and a constant voltage are contradictory, so far as a power unit of the type mentioned is concerned. The internal resistance, due to choke, valve and transformer, ensures that if the current rises the voltage falls, and vice versa. Therefore, either current or voltage or both are being wrongly measured. As the voltage is unvarying, while the current is not, suspicion falls first on the current measurement. Examining the meter circuit, a likely cause can be seen. It is the switch contact bringing in the shunt. The resistance of the shunt must be approximately one-hundredth of that of the meter itself (to convert the range from 1 to 100 mA); so, assuming a normal meter resistance, the shunt must be a fraction of an ohm. A poor switch contact might very appreciably increase this, altering the effective range of the meter and increasing the reading. A similar bad contact in the other part of the switch, connecting the series resistance, would be altogether negligible compared with half a megohm, and therefore an error in voltage reading is very unlikely.

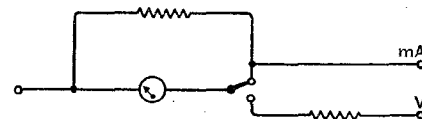

If switches are included at all in meter-shunt circuits they should be of very special low-resistance type. To be quite safe it is better to avoid them altogether and insert the switch in the comparatively high-resistance meter circuit. One way of doing this is shown.

Another disadvantage of Philip Cowe's arrangement is that as the switch does not close the shunt circuit before the shorting circuit the meter may possibly be damaged by excessive current.

Short-wave Broadcasting Stations

ARRANGED IN ORDER OF FREQUENCY

Station	Call Sign	Mc/s	Metres	kW	Station	Call Sign	Mc/s	Metres	kW
49 - Metre Band (6.000 - 6.200 Mc/s)					25-Metre Band (11.700-11.900 Mc/s)				
Moscow (U.S.S.R.)	RNE	6.000	50.00	20-100	Philadelphia (U.S.A.)	WCAB	9.590	31.28	10
Pretoria (South Africa)	ZRH	6.007	49.94	5	Athlone (Ireland)	—	9.595	31.27	—
Zeesen (Germany)	DJC	6.020	49.83	5-40	British Oversea Service	GRY	9.600	31.25	10-50
Moscow (U.S.S.R.)	RW96	6.030	49.75	20-100	Moscow (U.S.S.R.)	RAL	9.600	31.25	20-100
Boston (U.S.A.)	WRUL	6.040	49.67	20	Zeesen (Germany)	DXB	9.610	31.22	5-40
British Oversea Service	GSA	6.050	49.59	10-50	Cape Town (South Africa)	ZRL	9.606	31.23	5
Cincinnati (U.S.A.)	WLWO	6.060	49.50	50	Sydney (Australia)	VLQ	9.615	31.20	5
Philadelphia (U.S.A.)	WCAB	6.060	49.50	10	Budapest (Hungary)	HAT5	9.625	31.17	5
Motala (Sweden)	SBO	6.065	49.46	12	Rome (Italy)	I2RO3	9.630	31.15	25-100
Lima (Peru)	OAX4Z	6.080	49.34	15	Taihoku (Taiwan)	JFO	9.636	31.13	—
Tirana (Albania)	ZAA	6.085	49.30	—	Zeesen (Germany)	DJW	9.650	31.09	5-40
Rome (Italy)	—	6.097	49.20	25-100	Wayne (U.S.A.)	WCBX	9.650	31.09	10
Cape Town (South Africa)	ZRK	6.097	49.20	5	Perth (Australia)	VLW2	9.650	31.09	—
Belgrade (Yugoslavia)	YUA	6.100	49.18	10	Vatican City	HVJ	9.660	31.06	25
British Oversea Service	GSL	6.110	49.10	10-50	Manila (Philippine Islands)	KZRH	9.660	31.06	—
Saigon (French Indo-China)	FZR	6.110	49.10	12	Buenos Aires (Argentina)	LRX	9.660	31.06	7
Wayne (U.S.A.)	WCBX	6.120	49.02	10	Rome (Italy)	I2RO9	9.670	31.02	25-100
Lahti (Finland)	OFD	6.120	49.02	1	Zeesen (Germany)	DJX	9.675	31.01	5-40
Hsinking (Manchukuo)	MTCY	6.125	48.98	20	Paris Mondial (France)	TPA4	9.680	30.99	12-25
Pittsburgh (U.S.A.)	WPIT	6.140	48.86	40	Radio-Teheran (Iran)	EQU	9.680	30.99	14
Winnipeg (Canada)	CJRO	6.150	48.78	2	Sydney (Australia)	VLQ5	9.680	30.99	—
Wayne (U.S.A.)	WCBX	6.170	48.62	10	Moscow (U.S.S.R.)	RW96	9.684	30.98	20-100
Schenectady (U.S.A.)	WGEO	6.190	48.47	100	British Oversea Service	GRX	9.690	30.96	10-50
Vatican City	HVJ	6.190	48.47	25	Buenos Aires (Argentina)	LRA1	9.690	30.96	10
Rome (Italy)	IAC	6.355	47.20	25-100	Lisbon (Portugal)	CSW7	9.740	30.80	10
Radio Nations (Switzerland)	HBQ	6.675	44.94	20	Rome (Italy)	IRF	9.835	30.52	25-100
Valladolid (Spain)	FET1	7.070	42.43	—	Madrid (Spain)	EAJ7	9.860	30.43	10
41 - Metre Band (7.200 - 7.300 Mc/s)					Radio Nations (Switzerland)				
British Oversea Service	GSW	7.230	41.49	10-50	Bandoeng (Java)	PMN	10.260	29.24	1.5
Tokio (Japan)	JVW	7.257	41.34	50	Zeesen (Germany)	DZC	10.290	29.16	5-40
British Oversea Service	GSU	7.260	41.32	10-50	Ruyssedele (Belgium)	ORK	10.330	29.04	—
Lisbon (Portugal)	CSW8	7.260	41.32	10	Buenos Aires (Argentina)	LSX	10.350	28.99	12
Zeesen (Germany)	DXM	7.270	41.27	5-40	Lisbon (Portugal)	CSW6	11.040	27.17	10
Paris Mondial (France)	TPB7	7.280	41.21	12-25	Radio Nations (Switzerland)	HBO	11.402	26.31	20
Zeesen (Germany)	DJI	7.290	41.15	5-40	Moscow (U.S.S.R.)	RIC	11.640	25.77	20-100
Moscow (U.S.S.R.)	RWG	7.360	40.76	20-100	Rome (Italy)	IQY	11.673	25.70	25-100
Moscow (U.S.S.R.)	RKI	7.520	39.89	20-100	31 - Metre Band (9.500 - 9.700 Mc/s)				
Cairo (Egypt)	SUX	7.865	38.14	10	Chungking (China)	XGOY	9.500	31.58	35
Bangkok (Thailand)	HSP6	7.968	37.65	10	Bangkok (Thailand)	HSSPJ	9.500	31.58	10
Moscow (U.S.S.R.)	RIA	8.070	37.17	20-100	Mexico City	XBWV	9.500	31.58	10
Budapest (Hungary)	IAT4	9.125	32.88	5	Lahti (Finland)	OFD	9.500	31.58	10
Bucharest (Rumania)	—	9.280	32.33	—	Belgrade (Yugoslavia)	YUC	9.505	31.56	1
Radio Nations (Switzerland)	HBL	9.345	32.10	20	British Oversea Service	GSB	9.510	31.55	10-50
Ankara (Turkey)	TAP	9.465	31.70	20	Moscow (U.S.S.R.)	RW96	9.520	31.51	20-100
St. John's (Newfoundland)	VONG	9.482	31.64	—	Paris Mondial (France)	TPC13	9.520	31.51	12-25
25-Metre Band (11.700-11.900 Mc/s)					Paris Mondial (France)				
Motala (Sweden)	SBP	11.705	25.63	12	Pretoria (South Africa)	ZRG	9.523	31.50	5
Paris Mondial (France)	TPA4	11.720	25.60	12-25	Schenectady (U.S.A.)	WGEO	9.530	31.48	100
Winnipeg (Canada)	CJRXX	11.720	25.60	2	Moscow (U.S.S.R.)	—	9.530	31.48	20-100
Huizen (Holland)	PHI	11.730	25.58	20	Treasure Island (U.S.A.)	KGEI	9.530	31.48	20
Vatican City	HVJ	11.740	25.55	25	Calcutta (India)	VUC2	9.530	31.48	10
British Oversea Service	GSD	11.750	25.53	10-50	Tokio (Japan)	JZI	9.535	31.46	50
Rome (Italy)	I2RO15	11.760	25.51	25-100	Motala (Sweden)	SBU	9.535	31.46	12
Zeesen (Germany)	DJD	11.770	25.49	5-40	Zeesen (Germany)	DJN	9.540	31.45	5-40
Hsinking (Manchukuo)	MTCY	11.775	25.48	20	Pittsburgh (U.S.A.)	WPIT	9.570	31.35	10
Saigon (French Indo-China)	FZR	11.780	25.47	12	Millis (U.S.A.)	WBOS	9.570	31.35	10
Boston (U.S.A.)	WRUL	11.790	25.45	20	Madras (India)	VUM2	9.570	31.35	10
Tokio (Japan)	JZJ	11.800	25.42	50	Montevideo (Uruguay)	CXA2	9.570	31.35	5
Zeesen (Germany)	DJZ	11.801	25.42	5-40	British Oversea Service	GSC	9.580	31.32	10-50
Rome (Italy)	I2RO4	11.810	25.40	25-100	Melbourne (Australia)	VLR	9.580	31.32	2
British Oversea Service	GSN	11.820	25.38	10-50	Huizen (Holland)	PCJ	9.590	31.28	60
Wayne (U.S.A.)	WCBX	11.830	25.36	10	Cincinnati (U.S.A.)	WLWO	9.590	31.28	50
Perth (Australia)	VLW3	11.830	25.36	—	Dehi (India)	VUD2/3	9.590	31.28	10
Lisbon (Portugal)	CSW5	11.840	25.34	10	19-Metre Band (15.100-15.350 Mc/s)				
Paris Mondial (France)	TPB8	11.845	25.33	12-25	Moscow (U.S.S.R.)	RK1	15.040	19.95	20-100
Melbourne (Australia)	VLR3	11.850	25.32	2	Rome (Italy)	I2RO12	15.100	19.87	25-100
Zeesen (Germany)	DJP	11.855	25.31	5-40	Zeesen (Germany)	DJL	15.110	19.85	5-40
British Oversea Service	GSE	11.860	25.29	10-50	Vatican City	HVJ	15.120	19.84	25
Sydney (Australia)	VLQ2	11.870	25.27	—	Paris Mondial (France)	TPB6	15.130	19.83	12-25
Pittsburgh (U.S.A.)	WPIT	11.876	25.26	40	British Oversea Service	GSF	15.140	19.82	10-50
Paris Mondial (France)	TPA3	11.885	25.24	12-25	Motala (Sweden)	SBT	15.155	19.80	12
Chungking (China)	XGOY	11.900	25.21	35	Tokio (Japan)	JZK	15.160	19.79	50
Moscow (U.S.S.R.)	—	11.900	25.21	20-100	25-Metre Band (11.700-11.900 Mc/s)				
Moscow (U.S.S.R.)	RNE	12.000	25.00	20-100	Moscow (U.S.S.R.)	RNE	12.000	25.00	20-100
Zeesen (Germany)	DZH	14.460	20.75	5-40	Moscow (U.S.S.R.)	DZH	14.460	20.75	5-40
Radio Nations (Switzerland)	HBJ	14.538	20.64	20	Radio Nations (Switzerland)	HBJ	14.538	20.64	20
Rome (Italy)	IQA	14.795	20.28	25-100	Rome (Italy)	IQA	14.795	20.28	25-100

Wireless World

Station	Call Sign	Mc's	Metres	kW	Station	Call Sign	Mc's	Metres	kW
Moscow (U.S.S.R.)	RW96	15.180	19.76	20-100	British Oversea Service ..	GSG	17.790	16.86	10-50
British Oversea Service ..	GSO	15.180	19.76	10-50	Chungking (China)	XGOX	17.800	16.85	35
Lahti (Finland)	OIE	15.190	19.75	1	British Oversea Service ..	GSV	17.810	16.84	10-50
Ankara (Turkey)	TAQ	15.195	19.74	20	Rome (Italy)	I2R08	17.820	16.83	25-100
Zeesen (Germany)	DJB	15.200	19.74	5-40	Wayne (U.S.A.)	WCBX	17.830	16.83	10
Chungking (China)	XGOX	15.200	19.74	35	Athlone (Ireland)	—	17.840	16.82	—
Pittsburgh (U.S.A.)	WPIT	15.210	19.72	40	Zeesen (Germany)	DJH	17.845	16.81	5-40
Lisbon (Portugal)	CSW4	15.215	19.72	10	Paris Mondial (France) ..	TPB3	17.850	16.81	12-25
Huizen (Holland)	PCJ2	15.220	19.71	60	Radio Nations (Switzerland)	HBF	18.450	16.26	20
Podébrady (Bohemia) ..	OLR5A	15.230	19.70	15-30	Bangkok (Thailand)	HS6PJ	19.020	15.77	10
Paris Mondial (France) ..	TPC5	15.240	19.68	12-25	13-Metre Band (21.450-21.750 Mc's)				
Boston (U.S.A.)	WRUL	15.250	19.67	20	Boston (U.S.A.)	WRUL	21.460	14.00	20
British Oversea Service ..	GSI	15.260	19.66	10-50	British Oversea Service ..	GSH	21.470	13.97	10-50
Wayne (U.S.A.)	WCBX	15.270	19.65	10	Schenectady (U.S.A.)	WGEA	21.500	13.95	25
Zeesen (Germany)	DJQ	15.280	19.63	5-40	Rome (Italy)	I2R016	21.510	13.95	25-100
Delhi (India)	VUD3	15.290	19.62	10	Philadelphia (U.S.A.) ..	WCAB	21.520	13.94	10
Buenos Aires (Argentine) ..	LRU	15.290	19.62	7	British Oversea Service ..	GSJ	21.530	13.93	10-50
Rome (Italy)	I2R06	15.300	19.61	25-100	Pittsburgh (U.S.A.)	WPIT	21.540	13.93	40
British Oversea Service ..	GSP	15.310	19.60	10-50	British Oversea Service ..	GST	21.550	13.92	10-50
Schenectady (U.S.A.)	WGEA	15.330	19.57	25	Wayne (U.S.A.)	WCBX	21.570	13.91	10
Zeesen (Germany)	DJR	15.340	19.56	5-40	Schenectady (U.S.A.)	WGEA	21.590	13.89	100
Zeesen (Germany)	DZG	15.360	19.53	5-40	British Oversea Service ..	GRZO	21.640	13.86	10-50
Budapest (Hungary)	HAS3	15.370	19.52	5	11-Metre Band (25.600-26.600 Mc's)				
Moscow (U.S.S.R.)	RW96	15.410	19.47	20-100	Boston (U.S.A.)	WRUW	25.600	11.70	—
16-Metre Band (17.750-17.850 Mc's)					St. Louis (U.S.A.)	W9XPD	25.900	11.58	—
Zeesen (Germany)	DJE	17.760	16.89	5-40	Cincinnati (U.S.A.)	W8XNU	25.950	11.56	—
Paris Mondial (France) ..	TPC3	17.765	16.88	12-25	South Bend (U.S.A.)	W9XH	26.050	11.52	—
Huizen (Holland)	PHI2	17.770	16.88	20	Superior (U.S.A.)	W9XJL	26.100	11.49	—
Pittsburgh (U.S.A.)	WPIT	17.780	16.87	40	Nashville (U.S.A.)	W4XA	26.150	11.47	—
Bound Brook (U.S.A.) ..	WNBI	17.780	16.87	35	Stations of which the names are "indented" are working outside the regular broadcasting bands.				

Short-wave Receiving Conditions

PROSPECTS FOR JULY

(COMMUNICATED BY THE ENGINEERING DEPARTMENT OF CABLE AND WIRELESS, LTD.)

PROPAGATION conditions on short waves during May were particularly stable for the first ten days, but deteriorated during the latter part of the month as a result of ionosphere storms on the 18th and 22nd to 28th (inclusive). A sudden return to normal conditions was experienced during the last three days of the month.

Atmospherics were above normal on the following dates: May 1st-3rd (inclusive), 8th, 10th, 15th, 16th, 21st, 23rd and 25th to 29th (inclusive). The general rise in the average level of atmospherics may be attributed to the greater thunderstorm activity associated with summer months.

Sudden ionosphere disturbances of the "Dellinger" type were experienced in this country as under: (a) May 14th, 1750 GMT; its effect was mainly confined to South American stations. (b) May 17th, 1350 GMT; most stations were affected.

Particulars of the broadcast bands which, it is considered, are likely to prove most reliable during July on five selected routes are given below; these may serve as a guide when considering reception from places other than those mentioned. All times are GMT, on the 24-hour clock notation.

Tokio: 0800/1200, 16 m; 1200/1600, 16 or 19 m; 1600/mid, 19 or 25 m.

The time at which the longest wavelength is expected to be most necessary is about 1900, i.e., one hour before sunrise at Tokio. Echo signals are likely to occur around 2000.

Melbourne: 0800/1000, 19 or 25 m. Westward (via Pacific); 1500/2000, 25 m. Eastward (via Calcutta); 2000/mid, 25 m. Eastward.

Towards midnight reception should be possible on most days on both the Eastward and Westward routes on 25 metres, and frequently also on 19 metres. The period 1100/1400 is a difficult one at this season on account of

extreme differences in conditions at the two ends of the route.

Bombay: 0800/1600, 16 m; 1600/2000, 16 or 19 m; 2000/mid, 19 or 25 m.

Buenos Aires: 0800/1000, 25 or 31 m; 1000/1200, 16 or 19 m; 1200/1600, 13 or 16 m; 1600/2000, 16 or 19 m; 2000/mid, 19 or 25 m.

Echo signals may be expected around 2000. The most difficult period is likely to be from 0800/1000 when it is daylight here but later winter night at Buenos Aires.

Montreal: 0800/1000, 19 or 25 m; 1000/1200, 16 or 19 m; 1200/1600, 16 or 19 m; 1600/2000, 13 or 16 m; 2000/mid, 16 or 19 m.

Towards midnight slight echo may be discernible. During magnetic disturbances wavelengths longer than those mentioned may be found to be preferable, particularly during the morning and late evening periods.

In summer (northern hemisphere) it is generally found that the period of maximum daylight over a route is not necessarily that for which the shortest wavelength may be used. The reason for this is that at this season the critical frequency of the controlling layer towards sunset frequently exceeds that at noon; thus, in the case of transatlantic routes, the maximum usable frequency during the evening may be greater than that during the early afternoon, notwithstanding the greater daylight involved during the latter period.

Atmospherics are likely to be troublesome during the afternoons in July; the average intensity on the 16-metre band, for example, may be expected to increase from its noon value to a peak at about 1800.

If the present trend of magnetic activity continues, the most favourable conditions for long-distance reception during July will probably be during the last week.

Apparatus Reviewed

McClure Model ACA16 Amplifier

THREE STAGE 15-W PUSH-PULL UNIT FOR AC MAINS

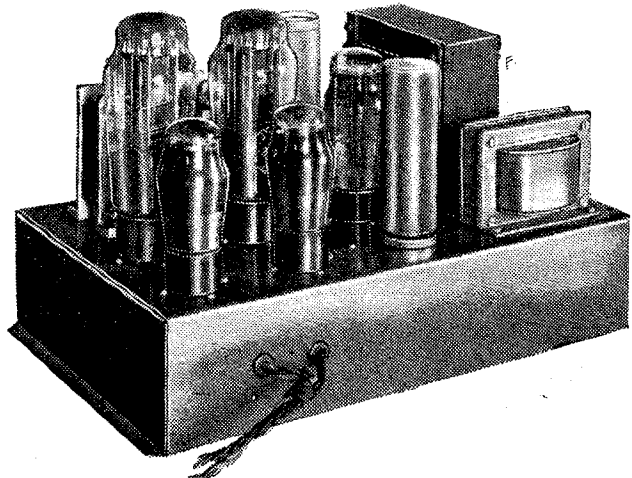

DESIGNED to work in conjunction with feeder units of the type reviewed in our March issue, this amplifier is fitted with a five-pin socket for supplying the necessary filament and HT current and connecting the input from the receiver.

The circuit comprises a first AF stage, a resistance-coupled phase-splitting stage and a final push-pull stage. Triodes are used throughout (Tungsram LL4s in the first two stages and P27/500s in the output stage).

On test the amplifier showed no visible trace of distortion on the cathode-ray oscilloscope up to 10 watts, and the amount present at 15 watts was not serious. Under normal conditions in the average house the amplifier will handle peaks with an ample margin in hand, as with a loud speaker of normal efficiency the average output called for will rarely exceed 4-5 watts.

Input/output curve of McClure 15-watt amplifier. Full output is given for an input of 3.9 volts RMS.

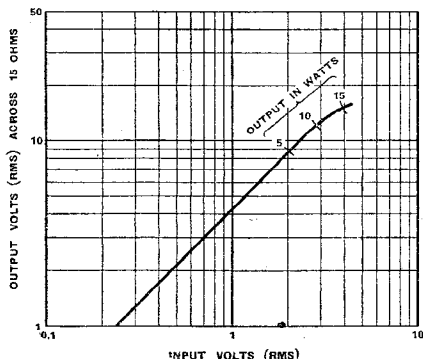

(Below) Frequency response of McClure Model ACA16 amplifier.

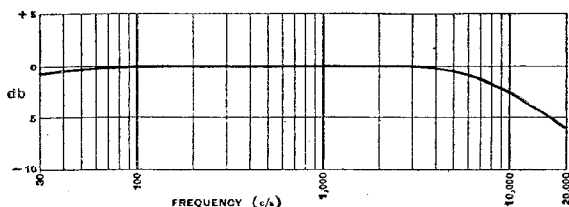

The frequency characteristic is very good, particularly in the bass, where the loss at 30 c/s is only 0.7 db. At the other end of the scale the 2.7 db drop at 10,000 c/s would not be noticed, and at 20,000 c/s the loss is only 6 db. These figures include the output transformer which in the model tested was wound for an output impedance of 15 ohms. Other values can be supplied.

The iron-cored components are all of generous design and the workmanship and finish are excellent. Complete with valves the ACA16 costs £8 18s. 6d., and the makers are John McClure, Ltd., Erskine Road, London, N.W.3.

"Mulparvo" Portables

RADIO RECEIVERS, DEAF AIDS AND COMBINED INSTRUMENTS

FITTING into a leather case measuring about $8\frac{1}{2} \times 4\frac{1}{2} \times 2\frac{1}{2}$ in., and weighing under 3lb., the "Mulparvo" portable is a very efficient little receiver, with ample range on its self-contained frame aerial for the reception of the Home and Forces programmes in most parts of the country.

The circuit consists of a detector with resistance-controlled reaction and

Very efficient for its size, the "Mulparvo" portable is also available as a combined radio receiver and deaf aid.

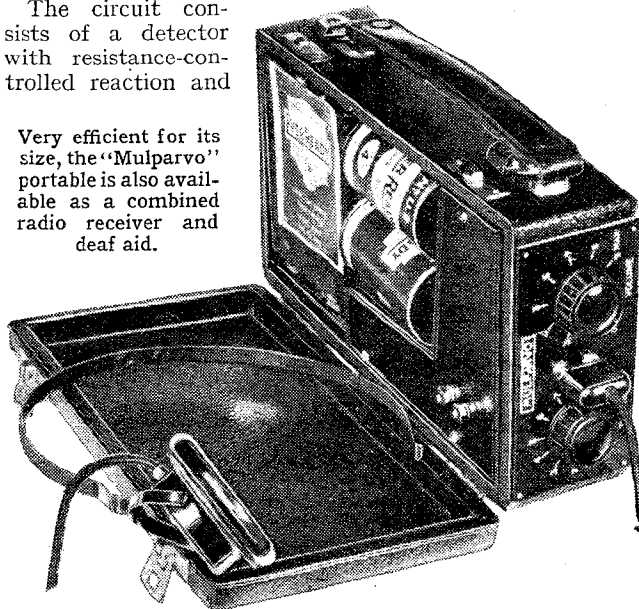

two transformer-coupled AF stages. Standard dry batteries of the deaf-aid type are used, and the valves are Hivac midgets (XD in the first two stages and XL in the output stage). The receiver gives an unexpectedly high performance for its size, and this is no doubt accounted for by the smooth reaction control backed by an AF gain above the average. Reception of Continental stations is well within the range of the receiver when a short aerial is connected to the terminal provided.

The finish and general construction of the set are very good indeed, and it should make the ideal "personal" set either for the civilian or the soldier. The price is £5 10s., and the leather case is £1 extra.

A combined radio set and deaf aid is also available. This instrument, which weighs $3\frac{1}{2}$ lb., and measures $9\frac{1}{2} \times 5 \times 2\frac{1}{2}$ in., makes use of a high-grade crystal microphone, and gives excellent reproduction with the slight increase of high fre-

Apparatus Reviewed—

quencies which most deaf people find beneficial. The price of the combined instrument is 14 guineas, or the deaf aid may be obtained separately at 10 guineas. A single earpiece of good characteristics is included with each type.

The makers are Mulparvo, Ltd., 17, Gillingham Street, London, S.W.1.

The Wireless Industry

WE have received a copy of List No. 163, the 1940 catalogue of A. F. Bulgin and Co., Ltd., By-pass Road, Barking, Essex. The components illustrated show no diminution in scope and variety and the firm are to be congratulated on their efforts to maintain adequate supplies for the experimenter.

An illustrated catalogue dealing with battery chargers and industrial rectifiers has been produced by The Electrical Construction Co., Ltd., Lamport Hall, Northampton. The elements used are of the selenium type.

Those engaged in research or production involving high-vacuum technique will be interested in a leaflet published by W. Edwards and Co. (London), Ltd., Southwell Road, Loughboro' Junction, London, S.E.5, describing three new Metrovac rotary pumps. These are Metropolitan-Vickers products and will fill the gap left by the stoppage in the supply of German pumps.

Mr. C. O. Hamer, formerly technical adviser and works superintendent of

British Ozaphane, Ltd., and E. H. Scott Radio Laboratories, Ltd., has now been elected managing director of these two companies.

Mr. Sidney Angell, formerly a director, and Mr. J. Silver sales manager, are no longer associated with these two companies.

Diversity Receivers

EQUIPMENT IN SOUTH AFRICA

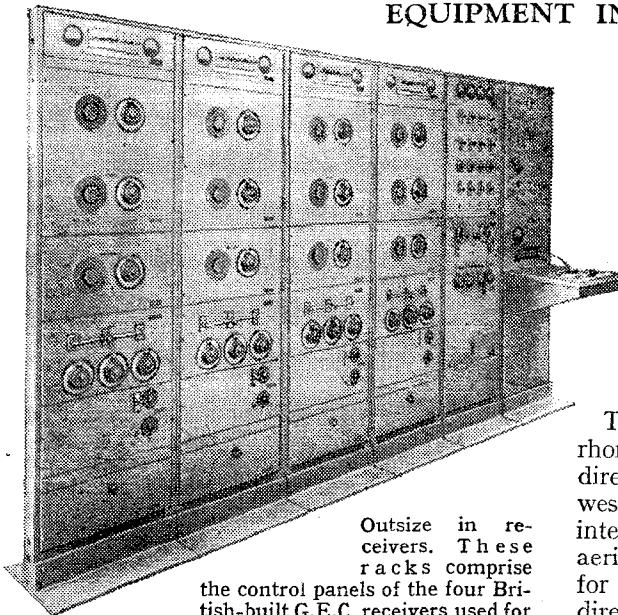

Outside in receivers. These racks comprise the control panels of the four British-built G.E.C. receivers used for the reception of European programmes for rebroadcasting in South Africa.

journal. Thanks to the manufacturers of the receivers, the General Electric Company, it is now possible to supplement that description with a photograph and additional details of the equipment.

There are at present three rhombic aerials, which are directed on central and western Europe, but it is intended that additional aerials shall later be set up for reception from other directions. The station is mainly intended for dealing with signals on wavelengths

between 13 and 30 metres, though it works quite effectively up to 49 metres.

Each of the three main G.E.C. receivers is an eight-valve superhet, and, in order to ensure precise syntony of all circuits, there is no ganged tuning; the three RF and three IF circuits of each set are individually tuned, though, of course, the latter do not require frequent readjustment. In accordance with the well-known principle of diversity reception, the receiver which is at the moment receiving the best signal from its aerial temporarily takes charge of operations, the grids of the amplifying valves of the others being automatically biased back to such an extent as to render them almost—or possibly entirely—inoperative. A fourth receiver, mounted on the same rack, acts as a stand-by.

THE Panorama receiving station of the South African Broadcasting Corporation was described at some length in the March issue of this

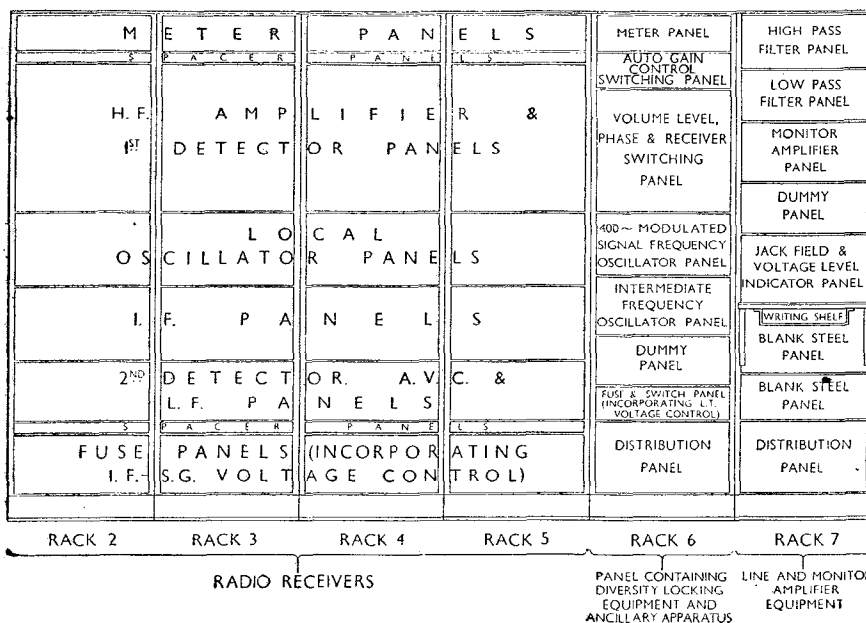

This key shows the functions of the various panels of the "diversity" receiving equipment illustrated in the photograph.

Current Topics

RECENT EVENTS IN THE WORLD OF WIRELESS

CAR RADIO: P.M.G.'s Embargo

THE Postmaster-General announced at the end of May that a Defence Regulation had been issued which provided that, apart from certain authorised exceptions, "no person shall use or have in his possession or under his control any wireless receiving apparatus installed in any road vehicle." Special attention is drawn to the fact that the announcement states that "any wireless receiving apparatus shall, notwithstanding that *it is not fixed in position* (for example, a portable set), be deemed for the purposes of the regulation to be installed if it is in the vehicle in circumstances in which it can be used or readily adapted for use."

All ordinary receiving licences for road vehicles were cancelled on May 31st, when it was announced that all apparatus (including aerials) installed in motor cars or other road vehicles had to be removed by June 2nd whether the vehicle was at present in use or laid up.

The licences in respect of these vehicles are to be retained by the owners. Whilst no refund of the licence fee is to be made, the question whether an allowance can be granted in respect of the unexpired period will be considered when the present embargo is lifted.

A similar defence regulation has been in force in France since early this year.

The Postmaster-General states that he is unable to give a general exemp-

tion to persons or firms engaged in the supply or conveyance of radio sets to customers or the collection of receivers for repairs. In this connection, no difficulty would appear to arise in regard to mains-operated receivers which could not be used in a vehicle. In the case of battery operated sets, whether "portable" or not, it should be arranged if possible that the battery is carried on another occasion or alternatively is kept separate from the receiver, and is securely wrapped and sealed.

R.A.O.C. RECRUITMENT

THE Royal Army Ordnance Corps has introduced a voluntary recruitment scheme for men with special technical qualifications or knowledge, to be enlisted as storemen and clerks. Applications are required from men between the ages of 20 and 50, who are well grounded in the principles of commercial organisation, especially the reception, control and issue of various stock, including wireless parts. The particular need is for men with supervisory experience, and recruits of this calibre stand a good chance of early promotion.

An unmarried private in the R.A.O.C. receives 19s. 3d. per week, which rapidly rises to £1 13s. 3d.

Application forms may be obtained from The Chief Ordnance Officer, Royal Arsenal, Woolwich, London, S.E.18.

LISTENING TO SWITZERLAND

IN summer, those in the more distant parts of Europe find reception of the Swiss national medium-wave stations difficult; often it is only possible at night, and even then is subject to interference. The Swiss P.T.T. accordingly decided that the rebuilt Schwarzenburg S-W station should include, apart from the directional transmitters, an "all-round" transmitter to serve Europe. This station is now carrying out daily test transmissions from 12.0 noon to 1.45 p.m. (B.S.T.) on 6.165 Mc/s (48.66 metres). Reports will be greatly welcomed by the Short Wave Section of La Service de la Radiodiffusion Suisse, Neuen-gasse 30, Berne, Switzerland.

RATIONING RADIOGRAMS

AN order came into force on June 6th restricting the supply to the home market of a large number of articles commonly used but not essential. Radiogramophones are scheduled as controlled goods, but wireless receivers, amplifiers, and loud speakers are excluded.

The order required all manufacturers of and wholesale dealers in controlled goods to apply to the Board of Trade for registration before June 20th. Under the order manufacturers and wholesalers will be permitted to supply to retailers during the six months to November 30th approximately two-thirds of the value of their pre-war requirements.

TELEVISION STANDARDISATION

R.C.A. Statement

THE Radio Corporation of America, in defence of its adoption of the American R.M.A.'s television standard of 441 lines 30 frames, has issued a statement saying that it believes these standards incorporate the best features that have been developed in the United States, England, Germany and the rest of the world.

During the course of a recent F.C.C. investigation, the suggestion was made that television receivers should be manufactured that would be able to receive transmissions from stations operated under other standards as well as under those of the R.M.A. Whilst being prepared to build such receivers in order to overcome the present deadlock, the R.C.A. does not believe that the adoption of such a suggestion would prove to be of advantage either from an engineering, economic or public service standpoint.

COLONIAL WIRELESS CHAIN

THE setting up of a chain of Colonial wireless telegraph and telephone installations by Cable and Wireless was announced by Sir Edward Wilshaw, chairman, at the recent general meeting. In anticipation of the Government's approval of the scheme, which was proposed last year, the sets had been ordered and were therefore ready for despatch in the early days of the war.

"As an auxiliary service in cases of emergency or the interruption of the cables," said Sir Edward, "they should add greatly to the flexibility of our system, bringing to the Colonial empire the advantages already existing on what I may describe as the main lines of our traffic."

ENEMY ALIENS' RECEIVERS

THE Home Secretary announced on June 6th that an Order had been made prohibiting enemy aliens from having in their possession, or under their control, any wireless transmitting or receiving apparatus. Any enemy alien who is in possession of such apparatus must dispose of it

Current Topics—

forthwith. No part of the wireless licence fee will be refunded.

It was learned on enquiry at the G.P.O. that relay apparatus installed in subscribers' houses does not come under this ban because the subscriber has no control over the apparatus.

THE U.I.R.

IN an earlier issue it was stated that the war having so restricted the activities of the International Broadcasting Union (U.I.R.), the Geneva office would probably be transferred to the Control Centre of the Union at Brussels. In view of the recent invasion of Belgium, it will be evident that this rumoured removal did not take place. It was agreed at a meeting in April that, in spite of the difficulties, the work both at Geneva and Brussels should be carried on.

It is not yet known whether the Brussels checking station will be in a position under Nazi rule to continue its work of policing the ether.

FROM ALL QUARTERS

Tribute to Radio Officers

MR. H. A. WHITE, chairman of the Marconi International Marine Communication Company, at a recent meeting paid tribute to the endurance and continuous heroism of the radio officers in the company's service, twenty-three of whom had lost their lives, including three who were serving on the *Rawalpindi*.

WLWO Testing

THE recently completed 50-kW transmitter of the international short-wave broadcasting station WLWO of the Crosley Corporation, Cincinnati, U.S.A., is now conducting test transmissions on 9.590 Mc/s (31.28 metres) and 6.060 Mc/s (49.50 metres). The higher frequency is generally employed for transmissions between 4.0 and 8.0 a.m. and 11.45 a.m. and 9.0 p.m., whilst the lower frequency is used between 9.0 p.m. and 4.0 a.m. (B.S.T.).

Business as Usual?

IN the April issue of *QST*, a note from a German amateur is published in which he states that a number of German amateur transmitters have been relicensed and are operating in the usual manner. "Very subtle propaganda this, calculated to impress the neutrals, especially the Americas," comments the *T. & R. Bulletin*.

Philips

SINCE the invasion of Holland it has been announced that the registered office of the Dutch Philips companies at Eindhoven has been transferred to Curaçao in the Dutch West Indies.

Amateur F-M Transmissions

THE Federal Communications Commission recently modified the rules governing amateur stations to make available to American amateurs the band from 58.5 to 60 Mc/s for radiotelephone frequency-modulation transmissions. Previously amateurs were permitted to use radiotelephone frequency modulation in all amateur bands above 112 Mc/s. The change will provide a greater opportunity for experimental F-M transmissions since equipment is generally available for the lower band.

Naming Scientific Instruments

IN view of the confusion which exists over the naming of scientific instruments, a suggestion that there should be set up an authoritative body to whom the proposed name for an instrument could be submitted for approval will be received with interest. It is one of several such suggestions put forward by Mr. J. W. Williamson (formerly secretary of the British Scientific Instrument Research Association) in an article in the May issue of *The Journal of Scientific Instruments*, published by the Institute of Physics.

Patent Licences

IT is announced that arrangements have been made by the British Licensing Pool whereby the patents controlled by A. C. Cossor within the scope of the A5 Licence are available to licensees without payment of additional royalty.

N.P.L. Superintendent

DR. E. H. RAYNER retired from the post of superintendent of the Electricity Department of the National Physical Laboratory on March 31st, having attained the normal age limit. He has been succeeded by Mr. R. S. J. Spilsbury, formerly principal scientific officer in the department.

Radio Therapeutic Apparatus

"THE Application of Short Waves to Medical Science," is the subject of the address to be given by Dr. P. P. Dalton at the meeting of the British Institution of Radio Engineers, at 7 p.m. on Friday, June 21st, at the Federation of British Industries, 21, Tothill Street, Westminster, S.W.1. Readers of *The Wireless World* wishing to attend should apply for tickets beforehand to The General Secretary, Duke Street House, Duke Street, London, W.1.

B.B.C. European News Service

NEWS bulletins in English are radiated by the B.B.C. in the European short-wave service at the following times (B.S.T.):—

From GSA, 6.050 Mc/s (49.59 metres), and GSW, 7.230 Mc/s (41.49 metres), at 12.30, 1.30, 7.15 and 9.0 a.m., and 12.45, 2.15, 5.0, 7.0 and 11.0 p.m.

From GRX, 9.690 Mc/s (30.96 metres) at 12.30, 1.30, 7.15 and 9.0 a.m., and 7.0 and 11.0 p.m.

From GSE, 11.860 Mc/s (25.29 metres), at 12.45, 2.15 and 5.0 p.m.

I.E.E. Wireless Section

NO nominations having been received other than those proposed by the Wireless Section Committee of the I.E.E. for the vacancies which occur on the committee on September 30th, the following have been duly elected for the year 1940-41: Chairman, Mr. W. J. Picken (Marconi's W.T. Co.); vice-chairman, Mr. T. E. Goldup (Mullard); ordinary members, Messrs. L. W. Hayes (B.B.C.), T. H. Kinman (B.T.H.) and R. P. Ross (Signals Experimental Establishment) and Dr. R. L. Smith-Rose (N.P.L.).

Cossor Export Receivers

WE learn that A.C. Cossor, Ltd., have in course of production a high-performance short-wave broadcast receiver for operation from a 6-volt car battery. The circuit will be similar to those of the Model 396 EXZ and Model 396 ENU, which work from AC and AC/DC mains respectively. In these receivers there are three wavebands (13.6-40, 40-110 and 195-560 metres), and the 5-volt+rectifier circuit includes an RF stage. Voltage adjustment is provided for 100-125 and 200-250 volt mains in the case of the AC set, and 200-250 volts in the universal set. The permissible latitude in mains frequency is 40 to 100 cycles.

Valves in Part Exchange

IT was recently announced in Berlin that listeners wishing to purchase new valves would have to give an old valve in part exchange. A similar scheme is already in operation in regard to gramophone records.

A Coming of Age

CANADA'S pioneer radio station, CFCF at Montreal, celebrated its twenty-first anniversary on May 1st, when new studios and offices were officially opened. CFCF, which from 1918-22 used the call sign XWA, is owned and operated by the Canadian Marconi Company.

Export Enquiry

Y. T. WEN, Radio Service Engineer, 47, Marshall Road, Singapore, asks British firms to send catalogues of replacement parts, accessories, testing instruments, short-wave tuning units, etc.

Illegal Transmitter

AN eighteen-year-old Sedgley, Staffordshire, youth was recently fined £50 on a charge of possessing an unlicensed transmitter. The prosecution stated that the operator, using a call sign allotted to the R.A.F., was frequently heard transmitting messages to his friends. The transmissions, however, were in no way harmful to the country.

Identifying Troop Carriers

GERMAN troop carriers is the subject of the latest identification chart issued by *Flight*, Dorset House, Stamford Street, London, S.E.1. Priced at sixpence, post free, nine views of troop carriers as well as views of the German type of parachute are given on a conveniently folded card measuring 12½ × 10in.

NEWS IN ENGLISH FROM ABROAD

REGULAR SHORT-WAVE TRANSMISSIONS

Country : Station	Mc's	Metres	Daily Bulletins (B.S.T.)	Country : Station	Mc's	Metres	Daily Bulletins (B.S.T.)
America				India			
WXBI (Bound Brook)	17.780	16.87	5.0, 6.0.	VUC2 (Calcutta)	9.530	31.49	4.20 a.m.
WCAB (Philadelphia)	6.060	49.50	11.45 (Tu., Wed. and Fri), 12.0 midnight†.	VUM2 (Madras)	9.570	31.35	4.20 a.m.
WCAB	9.590	31.28	11.45 (Mon., Th. and Sat.).	VUD2/3 (Delhi)	9.590	31.28	4.20 a.m., 9.0 a.m., 1.30, 4.50, 6.30.
WCBX (Wayne)	15.270	19.65	8.30‡, 10.50§.	VUD3	15.290	19.62	4.20 a.m., 9.0 a.m.
WCBX	17.830	16.83	1.0, 2.0†, 3.0†, 3.15§, 4.0*†, 4.30§, 6.0, 6.30§, 7.55†.	Italy			
WGEO (Schenectady)	9.530	31.48	8.30†, 9.55§, 11.25‡.	I2R03 (Rome)	9.630	31.15	4.0 a.m., 7.35 a.m., 7.28, 10.15‡.
WGEO (Schenectady)	15.330	19.57	1.0, 2.0†, 9.55§.	I2R09	9.670	31.02	12.30 a.m.
WPIT (Pittsburgh)	15.210	19.72	6.0.	I2R04	11.810	25.40	4.0 a.m., 4.40, 8.25.
WRUL (Boston)	6.040	49.67	4.15 a.m.‡, 12.0 midnight†.	I2R06	15.300	19.61	4.0 a.m., 7.35 a.m., 12.15, 8.25.
WRUL	11.790	25.45	4.15 a.m.‡, 9.30§, 12.0 mid- night†.	I2R08	17.820	16.84	12.15, 4.40.
WRUL	15.250	19.67	9.30§.	Japan			
WLWO (Cincinnati)	6.060	49.50	7.25 a.m.	JZJ (Tokio)	11.800	25.42	9.5.
WLWO	9.590	31.28	7.25 a.m.‡, 1.15.	JZK	15.160	19.79	9.5.
Australia				Manchukuo			
VLQ (Sydney)	9.615	31.20	9.15 a.m.	MTCY (Hsinking)	11.775	25.48	7.30, 10.0.
VLQ2	11.870	25.27	9.15 a.m.	Rumania			
VLR (Melbourne)	9.580	31.32	10.0 a.m., 2.50.	Bucharest	9.280	32.33	10.0.
VLR3	11.850	25.32	9.50.	Russia			
China				Spain			
XGOY (Chungking)	9.500	31.58	10.30.	FETI (Valladolid)	7.070	42.43	8.50.
XGOY	11.900	25.21	11.30 a.m., 12.10, 10.30.	EAJ7 (Madrid)	9.860	30.43	12.30 a.m.
Finland				Sweden			
OFD (Lahti)	6.120	49.02	} 12.15 a.m., 8.55 a.m., 7.15, 10.15.	SBO (Motala)	6.065	49.46	10.45.
OFD	9.500	31.58		Turkey			
France				Turkey			
TPC13 (Paris-Mondial)	9.520	31.51	2.30 a.m., 5.45 a.m., 7.30 a.m.	TAP (Ankara)	9.465	31.70	8.15.
TPA4	9.680	30.99	9.15 a.m., 8.30.	TAQ	15.195	19.74	1.15.
TPA4	11.720	25.60	2.30 a.m., 5.45 a.m.	Vatican City			
TPB8	11.845	25.33	2.30 a.m., 5.45 a.m., 4.45, 8.30.	HVJ	6.190	48.47	8.0 (Tu.).
TPA3	11.885	25.24	8.30.	HVJ	11.740	25.55	2.30 (Mon.).
TPB6	15.130	19.83	9.15 a.m., 4.45.	Yugoslavia			
TPC5	15.240	19.68	2.0.	YUA (Belgrade)	6.100	49.18	8.30, 10.30.
TPB3	17.850	16.81	12.0 noon.	Spain			
French Indo-China				Sweden			
FZR (Saigon)	11.780	25.47	12.0 noon, 4.45.	SBO (Motala)	6.065	49.46	10.45.
Germany				Turkey			
DJC (Zeesen)	6.020	49.83	8.15, 11.15.	TAP (Ankara)	9.465	31.70	8.15.
DJI	7.290	41.15	11.15.	TAQ	15.195	19.74	1.15.
DJA	9.560	31.38	7.15.	Vatican City			
DJD	11.770	25.49	8.15, 11.15.	HVJ	6.190	48.47	8.0 (Tu.).
DJL	15.110	19.85	10.15 a.m., 2.15, 6.30, 7.15, 8.15, 9.15, 10.15.	HVJ	11.740	25.55	2.30 (Mon.).
DJB	15.200	19.74	5.15, 8.15, 9.15, 10.15.	Yugoslavia			
Hungary				Yugoslavia			
HAT4 (Budapest)	9.125	32.88	1.30 a.m.‡.	YUA (Belgrade)	6.100	49.18	8.30, 10.30.
HAT5	9.625	31.17	12.15 a.m.‡, 12.30 a.m.†.	Spain			
HAS3	15.370	19.52	3.55†.	FETI (Valladolid)	7.070	42.43	8.50.
				EAJ7 (Madrid)	9.860	30.43	12.30 a.m.

The times of the transmission of news in English for Europe from the B.B.C. short-wave station are given on the opposite page.

REGULAR LONG- AND MEDIUM-WAVE TRANSMISSIONS

Country : Station	kc/s	Metres	Daily Bulletins (B.S.T.)	Country : Station	kc/s	Metres	Daily Bulletins (B.S.T.)
Finland				Ireland			
Lahti 1	166	1,807	12.15 a.m., 8.55 a.m., 7.15, 10.15.	Radio-Eireann	565	531	6.45‡, 10.10 (10.5 Sun.).
France				Italy			
Radio Paris	182	1,648	10.15.	Rome 1	713	420.8	12.30 a.m., 7.28, 10.15‡.
"Radio 37"	832	360.6	6.45, 9.15, 10.45.	Milan 1	814	368.6	12.30 a.m., 7.28.
L'Île de France	1,204	249.2	6.45, 9.15, 10.45.	Latvia			
Germany				Latvia			
Bremen 2	224	1,339	10.15 a.m., 2.15, 5.15, 8.15, 9.15, 10.15.	Madona	583	514.6	10.0 (Tu. and Fri.).
Bremen 1	758	395.8	12.15 a.m., 10.15 a.m., 2.15, 5.15, 7.15, 8.15, 9.15, 10.15, 11.15.	Kuldiga	1,104	271.7	10.0 (Tu. and Fri.).
Hamburg	904	331.9	12.15 a.m., 10.15 a.m., 2.15, 5.15, 7.15, 8.15, 9.15, 10.15, 11.15.	Rumania			
Hungary				Rumania			
Budapest 1	546	549.5	11.10.	Bucharest	823	364.5	12.15 a.m., 2.30, 10.50‡.
				Russia			
				Russia			
				Sweden			
				Moscow 1	172	1,744	11.0, 11.30.
				Sweden			
				Falun	1,086	276.2	10.45.

All times are p.m. unless otherwise stated. * Saturdays only. § Saturdays excepted. † Sundays only. ‡ Sundays excepted. || Approx. times.

Morse Key Manipulation

CONTROL OF MUSCULAR MOVEMENT : AVOIDING FATIGUE

By H. F. JONES

IN view of the many hundreds of recruits to the morse key, and of the various opinions held regarding its manipulation, it is hoped that the following suggestions may prove of assistance to the beginner. They are the result of twenty years' experience of morse operating with British and American keys.

I am afraid that there will always be a difference of opinion on this subject, probably for the very good reason that hands also differ considerably as regards physical proportions. Moreover, British made keys are found in such a variety of shapes and sizes, with an equal variety of movement, that I am somewhat hesitant in recommending a definite line of attack. I am confident, however, that the following explanations will help to throw a light on most of the important points on which there is disagreement, at the same time offering substantial help and guidance to the beginner.

The question of muscular control possessed by the individual with regard to wrist movement has a most important bearing to each case. The

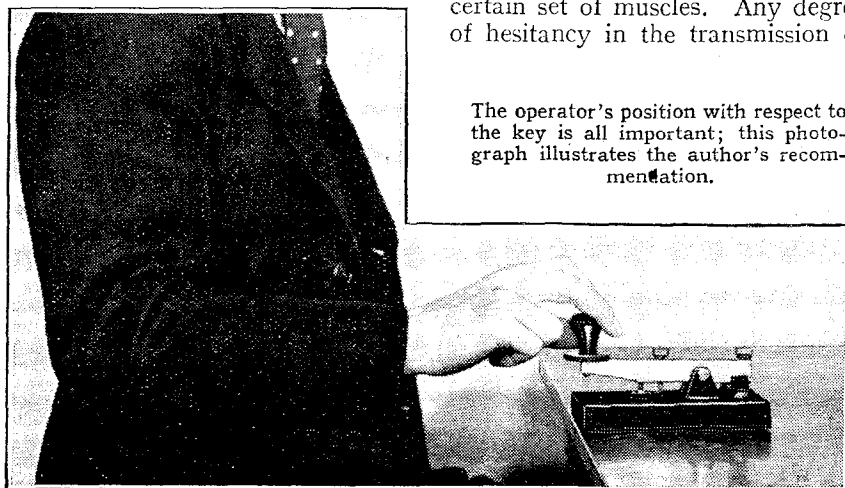

The operator's position with respect to the key is all important; this photograph illustrates the author's recommendation.

pianist, for example, endeavours to develop complete muscular control over finger action and wrist movement throughout the entire length of the keyboard. Similarly, the correct

manipulation of a morse key can only be accomplished by absolute control of wrist muscle movement. The beginner must realise at the outset that every movement of the morse key should be the result of deliberate, definite, predetermined wrist action. Close attention to detail in the preliminary stages is essential.

I propose to give, in the first place, a brief consideration to muscular movement in relation to wrist action as far as it concerns the manipulation of a morse key.

It is common knowledge that every movement of the body is accomplished by muscular action, the muscles receiving stimulation from the nervous system. They may be regarded as consisting of contractile tissues. That is, tissues which have the power, when stimulated, of instantly changing their shape. The nervous system controls and co-ordinates the working of all the various parts of the body. A wrist movement, for example, is accomplished by the brain and the nerves transmitting impulses to a certain set of muscles. Any degree of hesitancy in the transmission of

these impulses will obviously result in uneven action of the wrist. It is therefore important to concentrate on manipulating the morse key if perfect morse characters are to be

Controversy has arisen in our correspondence columns over the right method of manipulating a morse key. Here is an article by an instructor of long experience that throws light on the subject, and shows how the human machine may be used to best advantage

produced. There must be complete and perfect co-ordination between the brain, nervous system and the muscles; and no undue strain placed on any part of the system. Concentration, however, must be closely accompanied by a state of relaxation. The necessity for this is in order to avoid bringing into action various sets of muscles that are not directly responsible for wrist action, and only result in a state of fatigue.

Ease of Posture

It is of the utmost importance when taking up a position before the key to endeavour to hang the arm (from shoulder to elbow) loosely at the side. The top of the arm fits into a shallow cup in the shoulder blade, forming a ball-and-socket joint. It thus has a wide degree of movement. A variety of muscles are brought into action when the arm is moved. It is therefore reasonable to suppose that if the arm is hung loosely at the side no unnecessary muscular movement takes place, and therefore no fatigue can possibly come from that source.

The forearm (from elbow to wrist) consists of two bones, the radius and the ulna. These combine with the lower end of the arm and form a hinged joint. When the forearm is raised in order to place the fingers on the key two important muscles are stimulated. The biceps, situated in front of the arm, and the triceps, behind the arm. The forearm should be on a plane approximately

Morse Key Manipulation—

parallel with the table, so that the elbow is neither above nor below this level. In this manner, the strain on the muscles is fairly evenly balanced.

The wrist contains eight small cubic shaped bones, bound with ligaments and connected to the muscles by means of tendons. These bones articulate with the radius and ulna, to form a guiding joint, which is controlled by no fewer than twelve individual muscles. Each one of these muscles has its own separate connection to the nervous system. If, therefore, the rest of the body is in a state of relaxation, the ultimate control of the wrist will be so much more definite.

If the wrist is inclined to be awkward in movement, simple exercises may be profitably practiced. Moving the hand backwards and forwards and with a circular motion will do much to loosen up the muscles. Massage, in obstinate cases, will also help considerably. It will be found advantageous to commence manipulation practice by placing the first two fingers on the edge of a table and work the wrist to correspond with the morse characters.

This will also have the effect of loosening the wrist, and will tend to create a feeling of familiarity with the key even before it is handled.

The beginner is strongly advised to practice for a week, on the table, before touching the key. I can positively assure him it is time well spent, and it may be the means of saving much weary labour at a time when it can be ill-afforded.

The actual method of holding the key may depend upon physical proportions; whether one's fingers are long and slender, or short and

stumpy. In either case the position of the thumb should not vary. There is usually a groove at the side of the key knob, the thumb should be placed in this groove, and should remain there throughout the entire period of movement. The first two fingers should be slightly bent and placed on top of the key. If, however, the fingers are long and slender, they may be placed slightly over the knob of the key, with the first joints just bearing on the outer edge. The wrist should be made to fall and rise to correspond with the morse characters. Groups of dots comprising such characters as "I," "S," "H" and the figure "5" must be crisp, well defined, deliberate characters. The characters "C," "Q," "Y," "F" and "L" must also be well defined and deli-

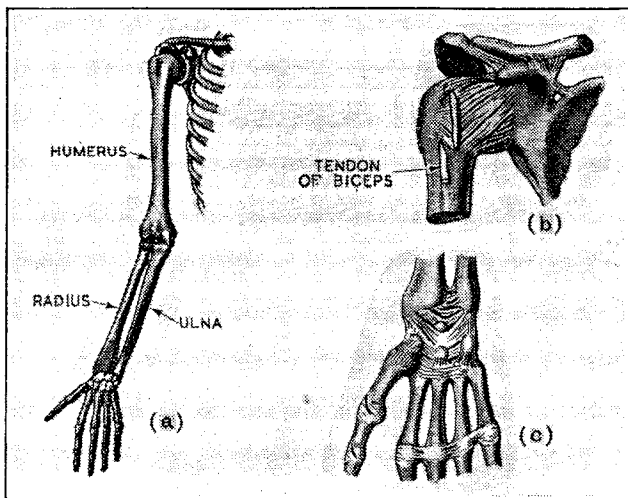

The bones of the human arm, as well as the small bones of the wrist mentioned in the text, are shown at (a). Articulations and dispositions of ligaments of shoulder joint and wrist are illustrated at (b) and (c).

berate groups. On no account rush the dots. It is such a common failing in the preliminary stages for the beginner to produce dots at a terrific speed, and the rest of the morse characters at a slow, uneven rate, the whole resulting in complete lack of style, and being quite unreadable. It is my firm opinion that the first month of key practice should be confined to developing a good style in manipulating the key. Once style is achieved, speed will follow of its own accord in a perfectly natural manner. It is suggested that

WEBB'S—
still the main source of
supply for **Communication Receivers and Radio Components.**

The rise in fame of Webb's as distributors of communication receivers—transmitters and suppliers to Government departments has recently overshadowed the component side of our business.

Any item for short-wave work—U.H.F.—modulation—test equipment, etc., can invariably be supplied from stock. Additional space for display and increased staff are ready for your service at our enlarged Soho Street premises.

- A few of the lines available*
RELAYS . DIALS . METERS
TEST EQUIPMENT
HEADPHONES
KEYS . VALVES
CONDENSERS
COMMUNICATION
RECEIVERS, etc.

ALL ENQUIRIES WILL RECEIVE OUR IMMEDIATE ATTENTION

WEBB'S RADIO

The Home of the Short-wave Enthusiast.
14, SOHO ST., OXFORD ST., LONDON, W.1.
Gerrard 2089.
Business Hours 9 to 6 o'clock. Saturdays 1 o'clock.

THE SUPERHETERODYNE RECEIVER

by Alfred T. Witts, A.M.I.E.E.

A well-known book which the R.A.F. aspirant in particular will find invaluable in his studies. It makes every detail of the subject understandable and provides the essential working knowledge required by every keen amateur, radio student and Service engineer.

4s.6d.net. (5/- by post)
Fourth Edition.

PITMAN
PARKER STREET,
KINGSWAY, W.C.2

Morse Key Manipulation—

particular attention be paid to the following points, especially the first, which is exceptionally important.

1. One of the secrets of successful key manipulation is in relation to spacing. At the completion of a letter character practice slightly raising the first two fingers from the key, just an eighth of an inch is sufficient. This will give the necessary space between the letters. On completion of a word, lightly touch the table to the right of the key. This will afford the correct space between words. Maintain this style of practice for at least a month; after which you will have developed the habit of automatic spacing. This style will never leave you; even at speeds of twenty-five words per minute the spacing will be well defined.

2. The key spring tension is important. It should be adjusted so that the contacts are separated by this tension, and not by the action of the wrist. No excessive effort, however, should be expended in "making" the key contacts. Otherwise the muscles will suffer from fatigue to the detriment of style.

3. Keep the thumb in permanent contact with the side of the key, but do not go to extremes and apply pressure to it.

On no account manipulate the key at a greater speed than you can comfortably manage. Speed will come with practice; and in any case, more harm is done, and valuable time taken in correcting the mistakes which could so easily be avoided by careful training in the preliminary stages. In these difficult days of abbreviated training, time will be saved, and progress achieved rapidly, if a good sound foundation be laid during the first month.

This article would not be complete without a brief survey of the American method of morse key manipulation. They favour a small morse key, very light and smooth in movement. It is usually fitted approximately eighteen inches to two feet from the front edge of the table. The forearm actually rests on the table, the movement is essentially a wrist movement. It cannot possibly be anything else. The results are not, in my opinion, sufficiently out-

standing to justify recommending that we change our method in favour of the American. But I have grown wiser with the years,

and have no intention of inviting a howl of righteous indignation from any of the various schools of thought.

Test Report

The "Double-Decca"

COMBINED AC/DC AND "ALL DRY" BATTERY PORTABLE (4 VALVES+RECTIFIER). PRICE: 10½ GUINEAS

THE title of this set is singularly appropriate, for it is virtually two sets rolled into one. Its small size, neat appearance, and the fact that it can be operated entirely from dry batteries gives it the status of a modern portable, while the ability to receive short waves when coupled to an outdoor aerial enables it to play the part of a permanent domestic receiver.

The duality is further emphasised in the power supply circuits, where the option is given of working from either mains or batteries.

Circuit.—Frame aerials wound with Litz wire are used for medium- and long-wave reception, and these are mounted, together with the short-wave aerial transformer, on

the back panel of the set. The medium- and long-wave windings are not shorted on the lowest waveband, and serve as a small-capacity aerial for the reception of the more powerful short-wave stations. The normal aerial input for the short-wave band is via a capacity leading to the top of the short-wave primary winding.

As far as the main course of the signal through the receiver is concerned, the circuit follows the standard practice of all-dry battery portables and makes use of a heptode frequency changer, pentode IF amplifier, single-diode-triode signal and AVC rectifier and first AF stage, and a pentode output valve. AVC is applied only to the IF stage.

The change-over from battery

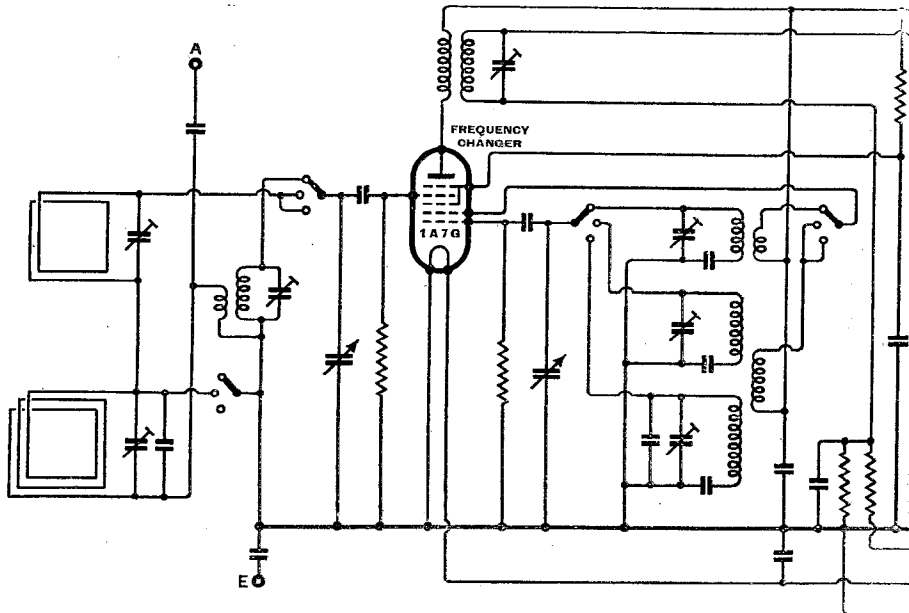

Circuit diagram of the Double Decca portable. On mains, a rectified and smoothed supply is provided for the filaments. The intermediate frequency is 380 kc/s.

to mains operation, although not automatic, is foolproof. A multiple switch connects the filament in parallel for battery operation and in series for mains. As the filaments are directly heated, it is necessary to rectify and smooth the supply current from the mains. This is effected by a combination of choke and resistance smoothing filters using electrolytic condensers of high capacity. The pilot lamp is connected in series with the rectifier valve heater.

Performance.—The sensitivity on medium and long waves is excellent and gives many foreign stations in addition to the B.B.C. Home Service when using the set on the internal frame aerials. Selectivity is good and there is a commendable absence of self-generated whistles.

The more powerful short-wave stations are just audible without an external aerial, but the latter is really essential for listening on the 16-49-metre band. The performance is then comparable with that given by a normal table model superhet

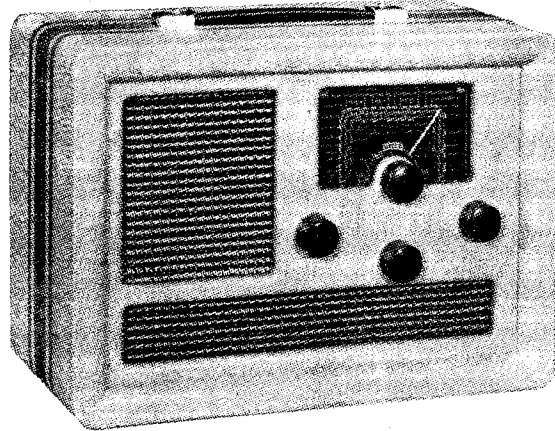

without an RF stage, but it is generally necessary to leave the volume control at maximum for all but the more powerful European short-wave broadcast stations. Tuning is somewhat critical near the bottom end of the waveband, and there is some tendency to "pulling" between oscillator and aerial circuits, but this did not prevent the successful reception of American stations under none too favourable propagation conditions.

Quality of reproduction is good if due allowance is made for the lack of bass inseparable from the use of a small-diameter loud speaker dia-

phragm (4 inches) and the compact dimensions of the cabinet. The efficiency in the middle and upper parts of the musical scale is high, and all programme material, including speech which calls for clarity rather than a broad bass response is dealt with faithfully.

Constructional Features.—The cabinet design has been well thought out, and the front panel has been recessed so that the control knobs do not project beyond the edges of the case. Indirect illumination against a black background is provided for the tuning dial when the set is used on mains.

WAVERANGES

Short ...	16-49	metres
Medium	200-550	metres
Long ...	1000-2000	metres

The chassis consists of a flat plate screwed parallel to the front of the cabinet on distance pieces, and the tuning condenser and volume-control spindles pass through this plate at right angles. The valves are mounted horizontally.

Access to the combined LT and HT dry battery is obtained by lifting a hinged flap at the back of the set. Space is provided at the side of the battery for stowing the mains lead. This contains the resistances for feeding the valve filaments, and should not be reduced in length.

The HT consumption in the particular receiver tested was 13.5 mA with a new battery.

MULTICORE SOLDER

MANY technical improvements are to be found in this product of Multicore Solders, Ltd., Bush House, London, W.C.2. Instead of the usual single core of rosin, there are three cores of smaller diameter distributed evenly in the body of the solder.

The flux used is chemically similar to rosin, but is treated to ensure uniformity of melting point and greater fluxing action at soldering temperatures. It is non-corrosive and has been approved for use by the G.P.O. and the A.I.D.

A wide range of alloys is available for different purposes, and the wire may be obtained in gauges from 10 to 22 SWG.

Full details and some very interesting general information on solders and fluxes is contained in a well-prepared booklet which has been recently issued by the Research Laboratories of the firm.

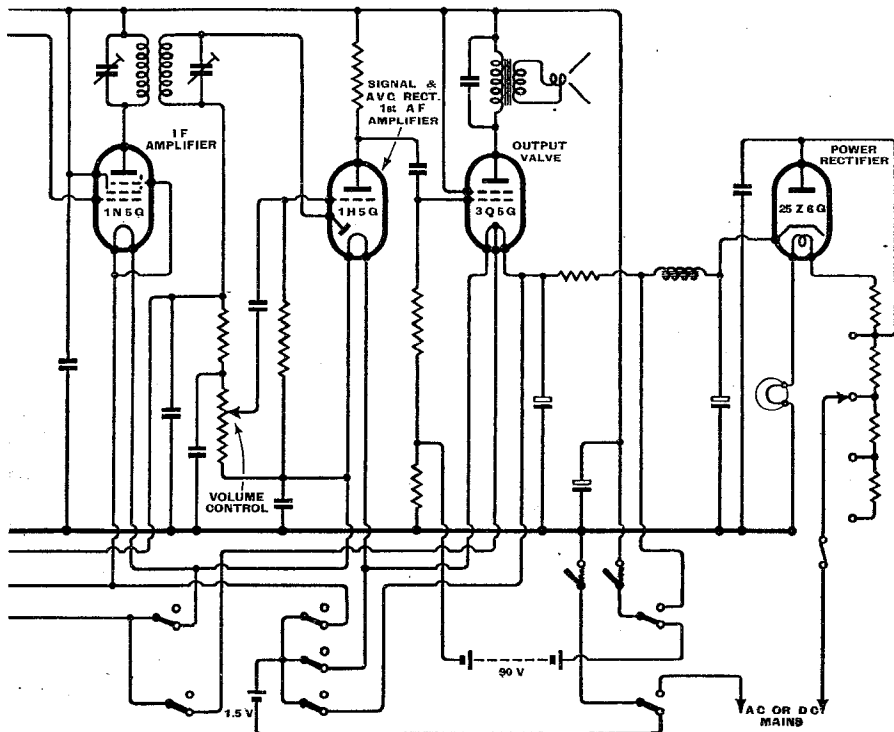

Rationalising Broadcast Receivers

ECONOMY IN LABOUR AND MATERIAL:
SUGGESTIONS FOR A "TOTAL WAR" PLAN

By J. A. SARGROVE, N.C.Mech.E., F.T.S.

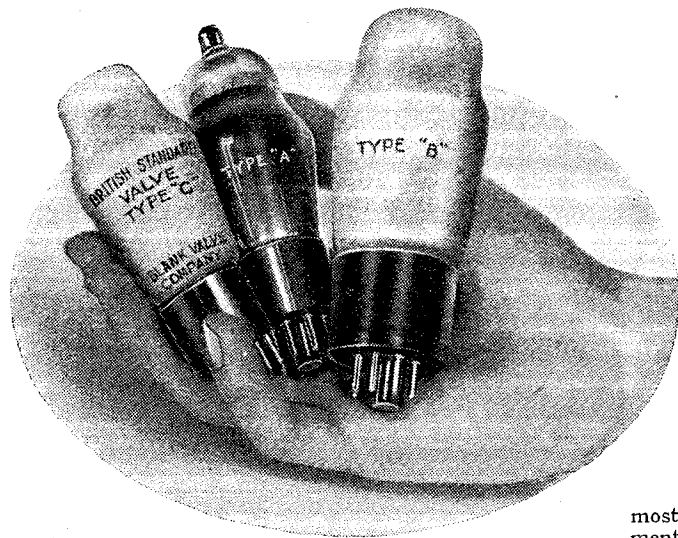

A plan for furthering the war effort, both by increasing export and by releasing technicians for direct war work. The author proposes a drastic simplification of valve types, together with standardisation of components and appropriate changes in receiver design.

The author suggests that three mains valve-types would satisfy most of the requirements of receiver design.

British Empire, which we have hitherto sadly neglected. It will be generally admitted that by following divergent directions the radio industry has not made it easy to achieve our right place in this market.

In trying to put our house in order we must concentrate on a few basic facts, forgetting for the moment about specialised requirements for which it is quite obvious that specialised types of valves will always be required. We must concentrate on meeting those demands that represent the main bulk of radio valve applications, and we shall all agree that twenty to twenty-five types would be more than adequate to meet the requirements of any designer of radio receiving or allied apparatus. We must also avoid becoming too enthusiastic about the recently developed economy heaters of very low wattage but which have the undeniable disadvantage that they are thin and more fragile. Hence their reliability can never be so high as those of the more thoroughly tried thicker heaters.

THAT there are two schools of thought amongst radio engineers on the subject of standardisation was well brought out in the discussion that followed Mr. P. R. Coursey's lecture before the I.E.E. some weeks ago. Those who wish to standardise all parts of a radio receiver appear to be in the majority, but many fear that any form of standardisation would be impracticable, or even that it would have harmful results.

At subsequent meetings of the Standardisation Committee at the British Institution of Radio Engineers a much greater agreement in favour of standardisation was observable, and at the meeting held on Empire Day, May 24th, the scheme put forward by the author was seriously discussed and the proposals generally approved.

Aiding the War Effort

It was generally felt that in times like this every possible effort must be concentrated on placing the radio industry on a rational basis so that not only can it adequately satisfy home demand but increase our power of export, at the same time releasing for other more vital war industries highly skilled technicians and in particular jig and tool makers and tool designers,

whose task would be considerably simplified and reduced by the scheme outlined below.

In addition, considerable amounts of raw material could be saved, thus making good to some extent the loss of essential import materials. In addition, the proposed standardisation would very greatly reduce service engineering difficulties.

Let us start with valves, amongst the bewilderingly large numbers of which even a well-trained valve engineer finds it difficult to retain his sanity, there being well over a thousand types in existence. One has only to glance through *The Wireless World* 1940 valve issue, in which only the principal six British valve makers' lists are shown, to come to the conclusion that there is something seriously wrong with our industry.

It will be generally agreed that there are only some twenty-five basic functions which valves have to fulfil and that the vast multiplicity of types has arisen mainly through such causes as the adoption of various heater ratings, various valve bases, and different conceptions as to whether the anode or the grid should be brought out to the top cap or not.

The British radio industry must look at the world market as a whole, as we are blessed with the greatest potential market of all, that of the

One Range of Valves

Looking down the formidable range of British, International, American, and other types of valves, we shall find that the generally most useful and most widely used range is the so-called International series of 6.3 volt 0.3 amp. indirectly heated valves having the American octal type of base. Five out of six British valve manufacturers possess in their range an adequate number of types of this series, so that the general adoption of

Rationalising Broadcast Receivers—

the proposed scheme need not cause any great upheaval to the valve industry.

Of course, the higher voltage 0.3 amp. series heater types, such as rectifiers and output valves, must be included in the twenty to twenty-five types contemplated as the first step towards standardisation.

Turning from valves to receivers, it is suggested that further simplification can be readily effected by avoiding unnecessary duplication at present practised by practically every set maker in manufacturing both AC and

thousand smoothing chokes, consisting of the materials mentioned above. We might even adopt permanent-magnet speakers as a standard; in total weight of material they use less, and our own steel industry is capable of supplying all the magnets required without the necessity for drawing on any appreciable foreign supply, thereby saving more copper wire by eliminating the energised speaker.

In addition, all the ancillary parts, such as smoothing condensers of the electrolytic type, decoupling condensers, fixed resistors, and mica condensers, as well as potentiometers and volume controls, tuning condensers, coils, and IF transformers, could be standardised and the bewildering multiplicity of types would be greatly reduced, although our home and export requirements could still be adequately met. It is not intended to curb the set designer as regards the final product, but only to limit the diversity of components that are available to him.

More Drastic Simplifications

Once we have done this we can go even further. The proposals discussed on May 24th also included the evolution of all receivers designed around three basic types of valve. The first should fulfil as many purposes as possible, and several valves exist in our present range which can be used to perform the jobs of frequency changing: RF, IF, and AF amplification; de-modulation, AVC; twin input circuit mixing; BF oscillator, etc. All these functions can be performed by the triode hexodes, in particular by the type in which the first control grid of the hexode portion is common to the triode grid (see Fig. 1). There is no doubt the valve industry could readily develop an ideal type on

It is suggested that we should standardise the Octal base, here seen actual size.

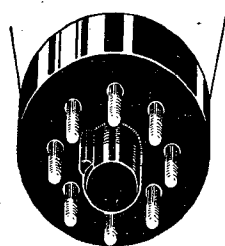

these lines that would so perfectly fulfil the above requirements that all diversity could be eliminated and the same valve used for all the above purposes in all receivers.

The second basic type is an output tetrode, and a valve of the 25L6G class is suggested. As this valve has been designed to operate with a screen voltage of the order of 100 volts, it can

The "Fluxite Quins" at work

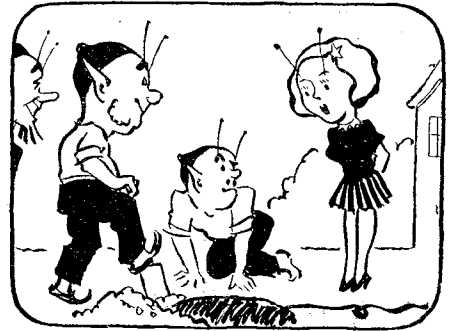

Said "Eh," that is "Ee" with the girth,
"You ask why I dig up the earth,
Well the earth tave, my dear
Has broke loose,—so it's clear
Here again will Fluxite prove its worth!"

See that **FLUXITE** is always by you—in the house—garage—workshop—wherever speedy soldering is needed. Used for 30 years in government works and by leading engineers and manufacturers. Of Ironmongers—in tins, 4d., 8d., 1/4 and 2/8.

Ask to see the **FLUXITE SMALL-SPACE SOLDERING SET**—compact but substantial—complete with full instructions, 7/6.

Write for Free Book on the art of "soft" soldering and ask for Leaflet on **CASE-HARDENING STEEL and TEMPERING TOOLS** with **FLUXITE**.

TO CYCLISTS! Your wheels will NOT keep round and true unless the spokes are tied with fine wire at the crossings AND SOLDERED. This makes a much stronger wheel. It's simple—with **FLUXITE**—but IMPORTANT.

THE FLUXITE GUN

is always ready to put Fluxite on the soldering job instantly. A little pressure places the right quantity on the right spot and one charging lasts for ages. Price 1/6, or filled 2/6.

FLUXITE LTD.
(Dept. W.W.),
DRAGON WORKS,
BERMONDSEY
STREET, S.E.1

ALL MECHANICS WILL HAVE

FLUXITE

IT SIMPLIFIES ALL SOLDERING

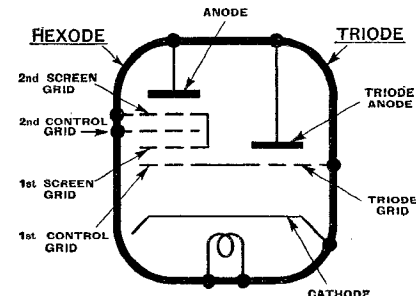

Fig. 1.—Electrode arrangement of the type of triode-hexode suggested by the author as a general-purpose valve.

AC/DC sets, between which there is no great difference in performance. This is a truly redundant state of affairs, since the typical AC/DC set is not seriously outclassed by the pure AC set. Even the difference in output volume is hardly appreciated by the general public, which, in the estimation of the writer, is generally unable to differentiate between volume levels of less than 10 db.

In present circumstances the proposed scheme therefore visualises the production of AC/DC sets for all normal requirements. They would have an output of the order of 2 watts, which is adequate for the home and most other uses.

Thus something like half a million mains transformers would be saved in a year. The main constituent parts of these (the high-quality soft iron) originates to a large extent in Sweden, whilst much of the copper wire has hitherto been obtained from Belgium.

In addition, in the smaller mains receivers, such as midgets, we can also dispense with the smoothing choke by the simple expedient of passing the semi-smoothed rectified supply to the anode of the pentode or beam tetrode output valve, and smoothing by means of a resistance in the HT supply to the screen of this valve and to the positive electrodes of the other valves.

This will save several hundred

Rationalising Broadcast Receivers—

be used for such low voltages quite efficiently, but can also be used at higher voltages for a larger output. In those cases where still more output is required, two or more of this type can be used in push-pull.

The third basic type required is a two-system indirectly heated rectifier of the type having a series-heated filament passing 0.3 amp. at approximately 25 volts. All electrodes would be brought out to separate pins.

A rectifier basically designed for RMS voltages of the order of 125 volts is equally usable at higher voltages if small series resistors are inserted in each anode lead. In those cases when a transformer-type rectifier system is required for yet higher voltages, two

would serve. The second type should be a beam tetrode having a 2.8-volt centre-tapped 0.05 amp. filament which could be operated either in series or in parallel with the first-named valve, which has an 0.05 amp. filament.

The writer will now attempt to show that these three basic valve types (the two last-mentioned battery valves are merely logical derivatives of the mains types) will in no way restrict the designer of apparatus either in the sensitivity that can be achieved, in the versatility of performance of the set, or in the fidelity of quality that is commercially required from the home receiver. It should be emphasised here that high-quality specialised apparatus (which only forms some

construction of the second control grid, but its slope can, in addition, be very conveniently varied by altering the fixed bias on the first control grid, as the virtual cathode of the tetrode is subject to control by the first control grid.

This gives us a very convenient method of varying the gain of an amplifier without requiring to alter the bias on the input grid proper. It will be readily appreciated that by the first control grid bias we can vary the stability of a straight RF amplifier, or in an IF amplifier a "Lamb" type noise limiter circuit can operate on grid 1 and so on.

One can also apply AVC voltage to grid 1 as well as to the input grid proper, thus making the AVC gain

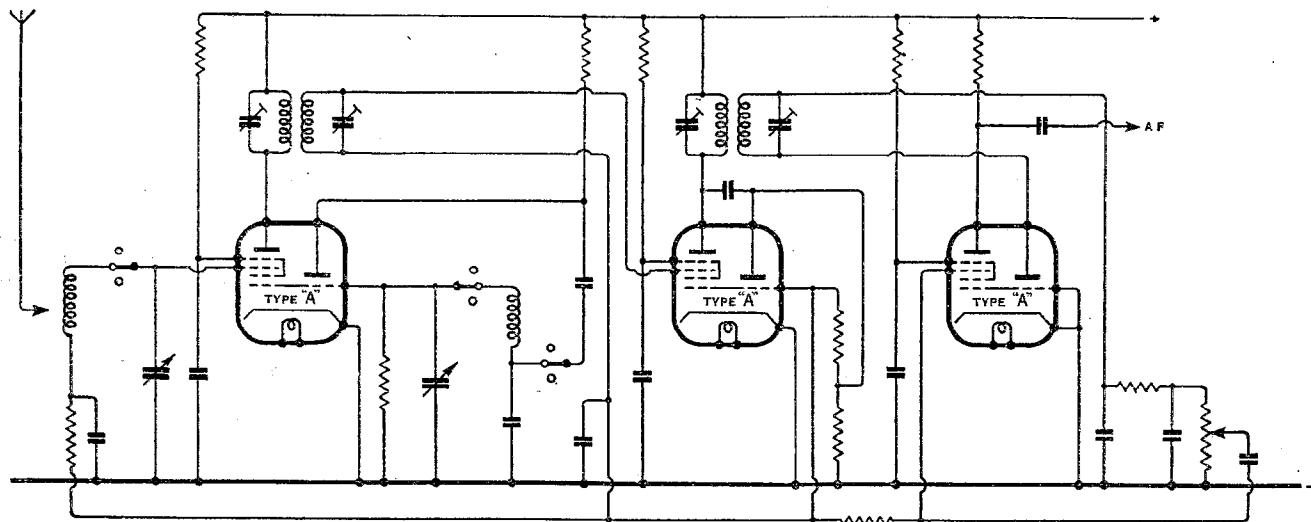

Fig. 2.—Simplified circuit diagram of the earlier stages of an AC/DC superheterodyne embodying the proposals made in this article.

of these can be used as a bridge circuit rectifier.

Thus it will be seen that most rectifier problems can be solved with one single Type 25Z6G rectifier, making all other types unnecessary and redundant.

It is clear that with the above three types one could cover something like 70 to 80 per cent. of receiver and other similar applications where mains supply is available.

In those cases where we have to content ourselves with a battery supply, analogous procedure could be followed by using at first four or five of the 1.4-volt range of valves, but ultimately we would concentrate on two basic types. First, we would need a triode-hexode of the type having the first grid of the hexode common to the triode grid, like the mains valve mentioned above. A Type 1A7G, or an improvement of it,

5 per cent. of the radio industry's total production) is not included in these considerations.

A triode-hexode of the type advocated gives satisfactory results as a mixer without any difficulty whatsoever down to about 13 metres. Such difficulties as exist at lower wavelengths can be overcome by using a two-valve frequency changer which the writer hopes to describe later.

RF, IF and AF Amplification

As an amplifier, this valve can be used quite easily by applying a constant potential of suitable value to the first control grid, thereby allowing the hexode portion to operate as a variable-mu tetrode consisting of the virtual cathode, the second control grid and the anode.

This tetrode has a variable-mu characteristic by virtue of the design

control operate at a higher rate.

The anode of the triode is a very convenient diode, the characteristic of which is also variable by the fixed bias applied to grid 1. Thus, if an IF amplifier constructed with this valve can have its own source of AVC in itself. An arrangement such as this is shown in the second stage of the basic circuit shown in Fig. 2. In the third stage of this circuit the same valve is used as follows: The first grid is at a fixed bias and the triode anode, acting as a diode, demodulates the signal in the usual way; audio-frequency voltages thus derived are applied to the second control grid of the hexode, which will thus act as a tetrode amplifier for audio-frequency signals.

As this grid has a variable-mu characteristic, one can apply the AVC voltage, or part of it, as bias and thus obtain the well-known but not very

Rationalising Broadcast Receivers—

frequently used feature of post-detector AVC, or what can be more correctly termed post-detector volume limitation.

By judicious adjustment of the design, matters can be so arranged that whatever the signal strength is above a certain limit the output valve is always fully loaded, but it cannot be overloaded.

A further feature can be conveniently incorporated in a circuit such as this. As shown in Fig. 2, fixed bias, which is normally applied in the cathode circuit of ordinary receivers, is omitted, and the input grids are prevented from reverting to cathode potential under no-signal conditions by the contact potential of the first control grid in the second stage.

Self-biasing

As shown in Fig. 3, the contact potential is that point on the grid-volts grid-current curve where grid current ceases to flow. If a grid floats freely in an electron stream, it will ultimately possess this potential provided its insulation is infinite.

With a finite leakage, say 3 to 4 megohms, as obtained from the AVC load and de-coupling circuits as shown in Fig. 2, the grid potential without signal will revert to some value around $1\frac{1}{4}$ volts, and so the input circuit at no-signal will be damped. This means that the set will have a threshold value and will ignore very small signals having a value comparable to the noise level of the set, but as soon as a signal is appreciable, the AVC derived from the second stage will push the grid bias of the first input grid to a value just larger than the contact

potential. The input circuit, now becoming undamped, will immediately give an appreciable signal which will be audible. In other words, by the simplest means and without the introduction of a special so-called "squelch" valve we have incorporated QAVC into this circuit. Thus three identical valves can give us greater apparent sensitivity than the

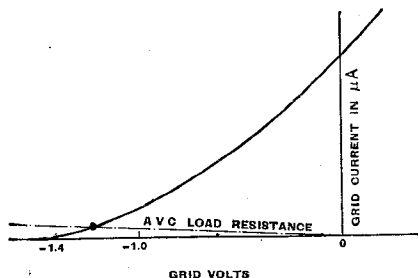

Fig. 3.—How the self-bias scheme works: grid volts-grid current curve for No. 1 grid of a triode-hexode.

usual combination of frequency changer; IF pentode; double-diode triode and, in addition, they will enable us to eliminate cathode resistors and by-pass condensers and we can have the extra attractions of post-detector limiter and QAVC. By following this combination of three Type A valves with one each of Types B and C we have a complete five-valve circuit. Of course, if more volume is desired, one or more Type B valves may be added, as mentioned above.

Fig. 4 shows a suggested arrangement for a two-plus-one-valve local station receiver which, by virtue of the electrodes available in the Type A valve, enables us to use an improved form of reaction control which, in addition to being very simple, has the

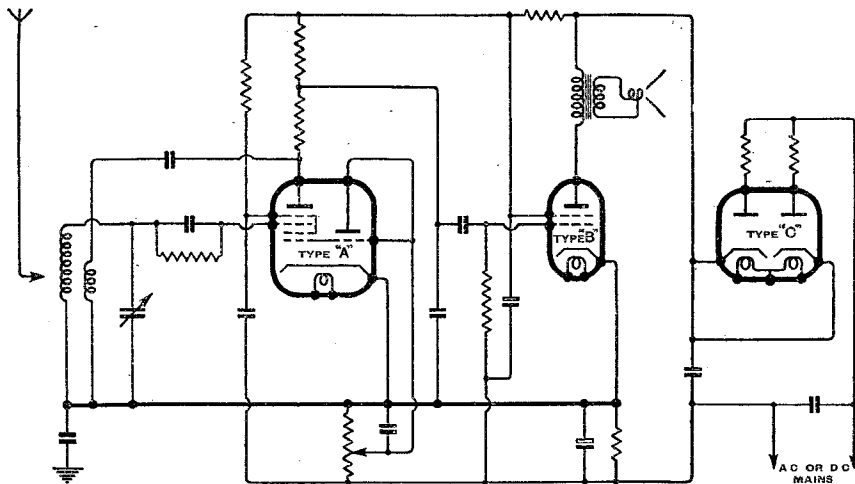

Fig. 4.—Simplified diagram of an inexpensive local-station receiver with space-change controlled reaction.

BULGIN

for SWITCHES

The Bulgin range of switches comprises over 130 different models: mains, toggle, rotary and push-button. These switches are known everywhere for reliability and exceptionally Q.M.B. action. The small rotary and mains switches can be used for practically every radio and electrical need.

The Rotary wave-change switches constitute some of the most advanced types available, and it is possible to assemble almost any combination desired. The Rotary midget selector switches also have an enviable reputation, and the uses to which these switches may be put are considerable.

ALL PRICES SUBJECT

List No.	Max. Volts	Price
S.45	32	4½d.
M.P.1/3	100	1/-
S.39	32	1/-
S.113	32	1/-
S.117	32	1/3
S.36	32	1/6
S.81.T	250	1/9
S.184	250	1/9
S.176	250	2/-
S.180	250	2/-
S.185	250	2/-
S.80.B	250	2/3
S.114	250	2/3
S.129	250	2/6
S.220	32	2/6
S.186	250	2/6
S.230	250	2/6
S.116	250	2/9
S.200 (R)	250	2/9
S.205 (R)	250	3/9
S.243/8 (R)	250	4/-
S.221/6 (R)	250	5/6
S.227/33 (R)	250	6/6

(R) denotes Rotary Type PLUS 16½% WAR INCREASE

RADIO SERVICE MANUAL

Write for this New Manual with its 280 pictorial and theoretical diagrams and clear concise text. Solves your problems.

1/-
post free.

FOR ALL RADIO COMPONENTS

This is an advert. of Messrs. A.F. Bulgin, By Post Ltd., Barking, Essex. Tel.: R1Ppteway 3474 (4 lines).

Rationalising Broadcast Receivers—

virtue that it does not alter the tuning of the input circuit.

By regulating the negative bias on grid 1, we vary the slope of the tetrode (constituted by the second control grid, second screen grid and anode) by reducing or increasing the space charge which is the virtual cathode of the tetrode; thus this type of reaction could be termed "space-charge controlled reaction."

It is clear that the industry, by limiting itself to three types of valves, sacrifices nothing. In fact, the designer has great scope and the performance of even the cheapest type of receiver can be improved.

The argument that the greater complexity of Type A valves, as compared with the simpler valves hitherto used in certain circuit stages, will increase the cost of the receiver can be dismissed by pointing out that if the valve industry makes only these few basic types, production costs will be reduced, and even the cheapest type of receiver can afford to use them.

Types D and E, which are the

battery equivalent of Types A and B, can, of course, be used more or less in the same manner, and, in connection with Type C, can form a battery-or-mains set.

It is difficult to see that any further type except these five should be necessary except for very special applications, which, as mentioned above, do not alter the substance of the argument.

It is hoped that these proposals will be taken by the industry as indicating a way in which we could all contribute very considerably to our country's war effort without in any way limiting the technical efficiency that is so important for the export market. To summarise, it is hoped that future designs will be based on—and even present designs altered to use—the international octal range of valves. After this initial step, the time will be ripe to consider the second, long-range proposal of three basic valve types which should actually give us a great advantage over our competitors by avoiding wasteful competition between ourselves.

New Wireless World Books

TELEVISION RECEIVING
EQUIPMENT : FIFTH
EDITION OF "WIRELESS
SERVICING MANUAL"

ALTHOUGH television is "on the shelf" for the duration of the war, there is no reason why we should forget all about it. On the contrary, a widespread technical knowledge on the subject will ensure that, when the service gets under way again, it will progress rapidly and smoothly. Now is the time for those who have neglected television to make good their omission; those who have merely dabbled in it have an opportunity of putting their knowledge of this extremely interesting subject on a sound foundation.

It is for such reasons as these that our publishers have decided to issue "Television Receiving Equipment," a 300-page book by W. T. Cocking, A.M.I.E.E., of *The Wireless World*. True to its title, it does not deal with the transmitting side except in so far as is necessary to explain receiving practice. Treatment is substantially non-mathematical, although design formulae have been included where necessary. To avoid recapitulation, it is assumed that the reader is familiar with "sound" broadcast practice. The book, which includes 167 illustrations and diagrams, some of large size, is now available, price 7s. 6d. net, or 7s. 10d. by post, from our publishers, Iliffe and Sons Ltd., Dorset House, Stamford Street, London, S.E.1.

Demands from those who have joined the wireless maintenance branches of the various services is largely responsible for the fact that a fifth edition of the "Wireless Servicing Manual," also by W. T. Cocking, has now been called for. Apart from routine revision, advantage has been taken of this opportunity to add a chapter on the use of cathode-ray gear for various purposes in receiver maintenance and testing. A new appendix describes the construction of a resistance and capacity bridge and a valve-testing bridge. The fifth edition costs 5s. net., or, by post from our publishers (address above), 5s. 5d.

KB Receivers for Export

TROPICAL CONSTRUCTION AND SPECIAL SHORT-WAVE
RANGES

THE Export Department at the Head Office of Kolster-Brandes, Ltd., Cray Works, Sidcup, Kent, devotes its whole time to the problems of producing and selling sets for use overseas. It is in constant touch with Government departments and export organisations and can bring expert knowledge to bear on enquiries from local agents abroad.

these will cover the requirements of most markets. It goes without saying that the construction has been veited from the point of view of resistance to high temperature and humidity.

Two of the sets are for AC mains. The "Raleigh" (KB830-0) has four valves+rectifier and covers 13 to 43 metres, 43 to 150 metres and 175 to 550 metres. In the "Drake" (KB850-0) there are three short-wave ranges: (1) 13-30 metres, (2) 30-75 metres, (3) 73-200 metres, and the medium-wave covers 200-545 metres. This set has an RF stage, and push-pull pentodes in the output stage delivering 8 watts undistorted.

Finally, there is the KB885-0 receiver for operating from AC or DC mains, the wave ranges and

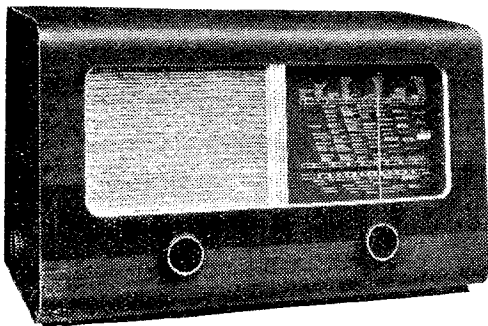

The KB885-0 receiver for operating from AC or DC mains.

Three sets form the basis of the KB export programme. In all these, attention has been given to the short-wave performance and the omission of the usual long-wave band has enabled the short-wave coverage to be extended. International octal valves are used throughout, so that there should be no difficulty regarding replacements. Alternative regional tuning scales are available, and

circuit of which are based on that of the KB830-0.

The cabinet work of all these models is of similar style to that of normal domestic receivers and the tuning scales are indirectly illuminated. A visual wave-range indicator is included.

The AC models are suitable for mains of 100-250 volts, 40-60 cycles, and the DC/AC model for 200-270 volts.

Random Radiations

By "DIALLIST"

History Repeats Itself

TELEVISION in the United States is running pretty true to the form that I predicted in these notes many long months ago. It was launched with one of the most terrific Press boosts of all time. The lay papers gave it huge headlines; the popular technicals devoted the greater part of several issues to it. The public rushed to see demonstrations. But the public, though eager to see television in the demonstration theatre, became strangely coy when asked to buy receivers for home use. Not long ago the head of a great manufacturing concern which has spared no effort to develop and to popularise television in the U.S. confessed that the sales resistance of the man in the street was unaccountably high. I've just been looking through the May issue of the New York *Radio News*. Not a single article on television; in fact the only reference to it in the reading pages is contained in a three-quarter column book review. And the advertisements? Here again I notice only one reference: a small advertisement by a correspondence school, offering training in "Radio plus Television."

Amateur Interest

Does this mean that the American amateur was never particularly interested in television, or that he has lost such interest in it as he had? I don't think so for a moment. The truth is that he is probably going through now very much what we went through some years ago. He was led by enthusiastic but misguided advance publicity to expect too much. In the very early days of wireless broadcasting people used to yearn for receivers that would reproduce as loudly and as clearly as the mechanical gramophones of the period: that was the natural standard of comparison, for both the wireless receiver and the gramophone are home instruments for the reproduction of speech and music. It was not long before the coming of the power valve and the balanced-armature loud speaker enabled the wireless set to equal the volume and improve on the quality of the mechanical gramophone. Then electrical methods were adopted for gramophone recording and reproduction. Both the radio receiver and the gramophone benefited equally from the develop-

ment of the moving-coil speaker and now they are in such close partnership that they are combined in the radiogram. It was only to be expected that people who didn't think very clearly would seek to draw a parallel with television and the home cinematograph. At first blush it might seem that the television receiver bore to the home ciné almost exactly the same relation as the wireless receiver bore to the gramophone. But it doesn't.



Now's Your Chance

WHEN the idea of a National Wireless Register was first mooted in this journal I sent in my name at once, for I wasn't then quite sure whether or not the Army would call me back again. As things turned out, it did, and I was soldiering again before August was out. Meantime, I'd had a line from the Wireless Register folk saying that they wouldn't be needing me at once. I've just had another, this time asking me to come along, if not already booked. Too late, I'm afraid, for I can't leave the present job. Many readers will have had the same letter and, if they're still free, I advise them not to delay about coming forward. They'll find the work intensely interesting and they will be with people easy to live and work with. I can assure any who are hesitating that there are real men's jobs to be done and that many fields for research of fascinating kinds are open. Fill up the form you've had, sign on the dotted line and come along. Perhaps you didn't fill up the first form giving particulars of your wireless attainments that was published in *The Wireless World* for January 26th, 1939. If so, it probably isn't too late now to make application. You can get this form by writing to The Air Ministry, S.7.e.5, Adastral House, Kingsway, London, W.C.2.



Learning Morse

THE recent correspondence on learning morse has been of special interest to me because for some weeks now I have been running a course for army signallers. Instruction takes place over telephone lines, its object being to enable the men to read "buzzer" accurately at 10-12 WPM. At first we were hard put to it to con-

VORTEXION

50w. AMPLIFIER CHASSIS

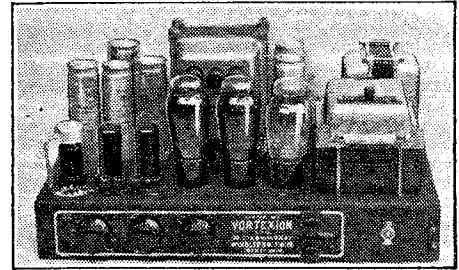

A pair of matched 6LG's with 10 per cent. negative feed-back is fitted in the output stage, and the separate HT supplies to the anode and screen have better than 4 per cent. regulation, while a separate rectifier provides bias.

The 6LG's are driven by a 6F6 triode connected through a driver transformer incorporating feed-back. This is preceded by a 6X7 electronic mixing for pick-up and microphone. The additional 6F5 operating as first stage on microphone only is suitable for any microphone. A tone control is fitted, and the large eight-section output transformer is available in three types:—2-8-15-30 ohms; 4-15-30-60 ohms or 15-60-125-250 ohms. These output lines can be matched using all sections of windings and will deliver the full response (40-18,000 c/s) to the loud speakers with extremely low overtone harmonic distortion.

- CHASSIS with valves and plugs £17 10 0
 Or complete in black leatherette cabinet with Collaro turntable, Piezo P.U. and shielded Mike Transformer £22 10 0
 Plus 10% War increase on above prices.
 Goodmans B.A. Speakers in stock.
- Reslo Horns £11 11 0
 Reslo M.C. Microphones £4 4 0
 All P.A. and A.R.P. Warning Gear in stock.

Many hundreds already in use for
A.R.P. & GOVERNMENT purposes

15w. AC & 12-VOLT DC AMPLIFIER

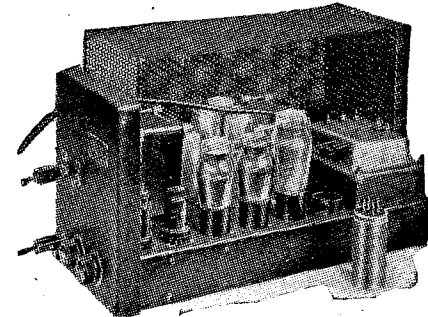

TYPE CP20

This small Portable Amplifier operating either from AC mains or 12-volt battery, was tested by "THE WIRELESS WORLD," October 1st, 1937, and has proved so popular that at Customers' demand it remains unaltered except that the output has been increased to 17.2 watts and the battery consumption lowered to 6 amperes. Read what "The Wireless World" said:—

"During tests an output of 14.7 watts was obtained without any trace of distortion so that the rating of 15 watts is quite justified. The measured response shows an upper limit of 18,000 c/s and a lower of 30 c/s. Its performance is exceptionally good. Another outstanding feature is its exceptionally low hum level when AC operated even without an earth connection. In order to obtain the maximum undistorted output, an input to the microphone jack of 0.037 volts was required. The two independent volume controls enable one to adjust the gain of the amplifier for the same power output from both sources, as well as superimpose one on the other, or fade out one and bring the other up to full volume. The secondary of the output transformer is tapped for loudspeakers or line impedances of 4, 7.5 and 15 ohms." Prices: Plus 10% war increase

- AC and 12-volt CHASSIS with valves, etc. £12 12 0
 Or in Rexine Case with Collaro Motor, Piezo P.U. and Mike Transformers £17 17 0
 AC only CHASSIS with valves, etc. £8 18 6
 Or in Rexine Case with Collaro Motor, Piezo P.U. and Mike Transformer £14 0 0
 Gauze Case for either chassis 12/6 extra.

Write for Illustrated Catalogue

Vortexion Ltd., 182, The Broadway, Wimbledon, S.W.19. Phone: LIBerty 2814

Random Radiations—

trive a buzzer that could be used in conjunction with the "spouted" microphone of the head-and-breast set. Experiments showed that good signals could be sent over some miles of none-too-good line by propping up a buzzer on a stand in such a way that the instructor could let the "spout" of his microphone just touch its frame. We have found that we get the quickest results by familiarising our pupils with the sounds of individual letters, making the dits at first as long as the experts dahs, or even longer. At the very beginning only four or five letters were taught during each short lesson. Each letter was sent at first very slowly until the pupil had got the "rhythm" of it into his head. Then dits and dahs were gradually shortened until their length was more or less normal. At the end of the lesson most of them could recognise letters when sent with quite short dits and dahs. The next lesson began with a recapitulation of the preceding one; then other letters were taught. In this way we found that men soon knew the alphabet with dits and dahs of normal length and that they could take down correctly groups of letters, so long as the intervals between letters were exaggerated. Syllables followed, with long intervals between letters to begin with. These could soon be brought down to something approaching normal, and we very soon had a good proportion of the men reading 5 WPM with dits and dahs of normal length, normal intervals between letters and exaggerated intervals between words.

Speeding Up

Hence I'm in agreement with Mr. C. F. N. Leahy (who wrote in the May issue) that one should aim at constant-length dits and dahs, but I don't think that one should start with them right at the beginning. It would work well enough to do so with simple letters, such as E, I, S, H, T, M, O, A, N; but I find that the more complicated combinations, such as C, F, P, L, Q, Y, and so on, are more quickly assimilated if the dits and dahs are made very long to start with and gradually shortened. The great thing, as Mr. Leahy says, is to preserve at all speeds the correct duration-ratio of dits and dahs—and that's no easy thing to do. Many instructors go all to pieces in this respect when they try to send slowly for beginners. His tip of running slowly a gramophone record of perfectly sent morse is an excellent one. I hope to try it out shortly. But, as he says, the crux

ORDER YOUR "WIRELESS WORLD"

To avoid waste, newsagents are no longer permitted to return unsold copies of journals, and so order no more than will cover their anticipated requirements. It is therefore imperative that readers should place a definite order with their newsagents; this is particularly important in the case of a specialised publication like *The Wireless World*. Orders can, of course, be countermanded from issue to issue in the event of change of address.

of the matter is to find perfectly sent records. Obviously, he knows some; will he be kind enough to give their numbers in a further letter so that the rest of us may benefit by his experience? I expect he'll agree with me that once you've got people reading well at 5 WPM with dits and dahs of normal length, it doesn't take long to work them up to double that speed by reducing the intervals between words. After all, the purpose of exaggerated intervals is to enable the pupil to think out the sounds that he has just heard. He is rather like a person trying to speak a foreign language when he can't think in it. As soon as you can think in a language, fluency comes rapidly. So with morse: once the brain automatically accepts — — — — as C, — — — — as P, and so on, speed in reading is quickly acquired.

Murphy Overseas Models

MODIFIED STANDARD RECEIVERS FOR EXPORT

THE exportation of wireless receivers is no new venture for Murphy Radio, Ltd., and they already have well-documented reports on standard models which have been called in for the past by listeners in all parts of the globe.

The knowledge acquired has been put to good use in developing the XA92—export version of the Model A92 "Station-master." There are two types, the Long-wave Model for European and other countries where long-wave stations are available, and the Standard Model which has an extra short-wave range, instead of the long-wave range. The actual coverage in the Standard XA92 is as follows: (1) 13-metre band; (2) 16-metre band; (3) 19-metre band; (4) 25-metre band; (5) 31-metre band; (6) 41-50-metre band; (7) 49-136 metres; (8) 190-550 metres.

Similarly in the XA90 and XD90 (export versions of the AC and universal sets in the "90" series) the Long-wave Model covers the normal ranges of 16.7-50 metres, 190-550 metres and 970-2,000 metres, while the Standard Model has two short-wave ranges bringing the coverage to: (1) 12.5-33 metres; (2) 40-110 metres; (3) 190-550 metres.

Not only are both these sets well suited to overseas use on account of their construction, which, in chassis and cabinet is designed to meet the climatic con-

ditions likely to prevail in any district where there are mains, but they are sets which have proved qualities for short-wave reception.

A very well prepared booklet describing and illustrating these receivers has been recently issued by Murphy Radio, Ltd., Welwyn Garden City, Herts, and has already been distributed to shippers and importers abroad.

News from the Clubs

Romford and District Amateur Radio Society

Headquarters: Red Triangle Club, North Street, Romford, Essex.
Meetings: Tuesdays, 8.30 p.m.
Hon. Sec.: Mr. H. G. Holt, 5, Butts Green Road, Hornchurch, Essex.

At meetings during April and May members have been demonstrating their home-built apparatus. Recently Mr. Voigt demonstrated his loud speaker and his new pick-up. H.M. forces are welcome at meetings.

Edgware Short-wave Society

Headquarters: Constitutional Club, Manor Park Gardens, Edgware, Middlesex.
Meetings: Wednesdays at 8 p.m.
Hon. Sec.: Mr. F. Bell, 118, Colin Crescent, Hendon, London, N.W.9.

The society are holding their first "Ham-fest" and social in the Shakespeare Hall of the Constitutional Club, Edgware, from 4 to 10.30 p.m. on June 29th. Several well-known manufacturers' apparatus will be exhibited. The new Voigt pick-up will be demonstrated. There will be a junk sale and a morse speed competition. A "Hamchat" will be given by the secretary of the R.S.G.B. A dance will be held in the evening. Admission 6d.

British Short-wave Correspondence Club

Headquarters: The Watering, Parham, Woodbridge, Suffolk.
Hon. Sec.: Mr. T. Knight, 50, Scott Street, Barrow-in-Furness, Lancs.

Members wishing to exchange SWL cards through the B.S.W.C.C. QSL service may obtain QRA lists from Mr. D. G. Garrard, 135, Hervey Street, Ipswich, Suffolk. Club stationery may also be obtained from this address.

During the month membership has steadily increased to 140, and the club now has members in all parts of the English-speaking world. Membership is free, and open to all radio amateurs. All enquiries must be accompanied by a stamped addressed envelope for reply.

Ashton-under-Lyne and District Amateur Radio Society

Headquarters: 17a, Oldham Road, Ashton-under-Lyne.
Meetings: Wednesday 8 p.m., and Sundays 2.30 p.m.

Hon. Sec.: Mr. K. Gooding, 7, Broadbent Avenue, Ashton-under-Lyne.

A lecture entitled "The Principles of Class A and B Amplification" was given recently by Mr. J. Cropper, who, in conjunction with Mr. W. P. Green, is renewing the series of lectures on the principles of the superheterodyne.

A special Morse class for beginners and new members is held every Monday at 8.30 p.m.

It has been resolved that all members serving with H.M. Forces shall become honorary members for the duration of the war.

Recent Inventions

Brief descriptions of the more interesting radio devices and developments disclosed in Patent

Specifications will be included in these columns.

SHORT-WAVE AERIALS

RELATES to a short-wave aerial which is mounted coaxially with a steel mast, say, that of a ship at sea. The invention is directed to ways and means for supporting the aerial so that any loss of power caused by the close proximity of the metal mast is reduced to a minimum. In some cases the mast itself is utilised as part of the aerial system.

As shown, the aerial consist of a single tubular element A, half a wavelength long, which is shorted to the metal mast M at its centre C, and is coupled at its lower end to a concentric feed line F.

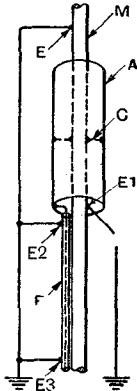

Low-loss mounting of SW aerial.

The metal mast is earthed at the points E, E₁, near the top and bottom of the aerial, whilst the feed line is earthed at the points E₂, E₃ which are half a wavelength apart. Since the end of the aerial is then, in effect, connected to the adjacent part of the mast by a short-circuited quarter-wave link, the impedance between these points will be high relative to the radiating impedance, so that currents will tend to flow into the aerial element, and standing waves on the mast will be largely suppressed. The short circuit at the centre C may be omitted, though this tends to narrow the band of frequencies which can be efficiently handled.

E. C. Cork and J. L. Pawsey. Application date, June 28th, 1938. No. 517772.

PUSH-BUTTON TUNING

EACH station-selecting button may, in addition to setting the circuits in tune, also modify them to give optimum reception of the particular programme chosen. For instance, a cam controlled by the button is arranged to loosen the coupling between two coils, so as to improve the selectivity when tuning to a distant station, or to tighten the coupling and so give a wider band-width for a local station. In the same way, the tone control of the set may be automatically adjusted to suit the wavelength of the particular station selected.

A special push-button is provided to convert the set from automatic tuning to manual control. At the same time the tuning indicator is changed, say, from the ordinary graduated dial used when tuning by hand to another type of indicator in which the station selected by switch control is identified by an

appropriate symbol, which is simultaneously projected in colour on to a ground-glass screen. The London transmitter may be indicated, for instance, by a picture of the Houses of Parliament, Paris by a picture of the Eiffel Tower, and so on.

Kolsier-Brandes, Ltd., and W. A. Beatty. Application date June 24th, 1938. No. 516385.

ELECTRON MULTIPLIERS

IT is found that surfaces such as caesiated silver, which give a high ratio of secondary emission when bombarded by primary electrons, have relatively low melting points and relative high vapour pressures. The consequence is that, when used in an electron multiplier, they tend to liberate a certain number of free ions, since the multiplier tube is usually highly evacuated.

The presence of such positive ions is undesirable, partly because they interfere with the normal flow of the electron stream through the multiplier, but more especially because they bombard the target electrodes. The impact causes the coated electrodes to fall off in secondary emission, and so shortens the effective life of the tube.

According to the invention, the multiplier tube is fitted with specially shaped electrodes which serve to deflect the positive ions out of the normal path of the negative electron stream, so that they leave it at an angle, and are collected separately, before they can do any damage.

Farnsworth Television Inc. Convention date (U.S.A.) June 5th, 1937. No. 515997.

THE problem of using an electron multiplier for the amplification of very high frequencies, or for the handling of a wide band of short-wave signals, as in television, is solved by operating the cathode at what is called a "tepid" temperature, e.g., between 100 and 150 deg. C. In these circumstances the electron emission is limited by the space charge, and there is a high ratio of the mutual conductance of the control grid to the current which the grid allows to pass.

A suitable cathode consists of a plate of silver coated with caesium, which emits electrons at a satisfactory rate

The British abstracts published here are prepared with the permission of the Controller of H.M. Stationery Office, from specifications obtainable at the Patent Office, 25, Southampton Buildings, London, W.C.2, price 1/- each.

when heated to a temperature of 100 deg. C.

Standard Telephones and Cables, Ltd. (Assignees of Le Matériel Téléphonique Soc. Anon.). Convention date (France), June 23rd, 1937. No. 515525.

A "MUTING" CIRCUIT

NEGATIVE feed-back is applied during the process of tuning from one station to another so as to remove interstation "noise." The feed-back, in effect, paralyses one of the amplifiers, preferably the last AF stage, though it may alternatively be applied to one of the radio- or intermediate-frequency valves.

As shown in the drawing, negative feed-back is automatically applied from the anode to the grid of a screen-grid tetrode through the branch circuit C, R

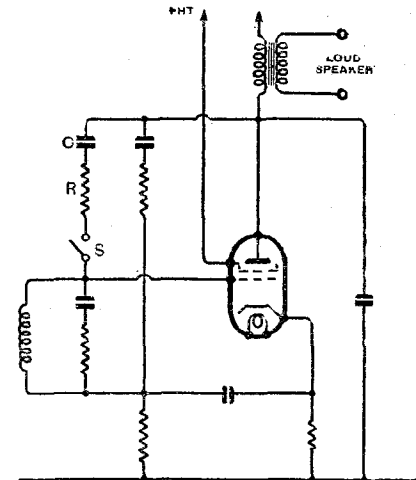

Silent tuning system

and a switch S, during the operation of tuning. The switch S is automatically closed by leaf-spring contacts on the spindle, the contacts being held together only so long as the spindle is in motion.

N. H. B. Brown. Application date, July 19th, 1938. No. 516504.

TELEVISION IMPROVEMENT

ASINGLE valve is used to separate the "framing" impulses from both the "line" impulses and the picture signals, particularly in interlaced systems of scanning. Advantage is taken of the comparatively long duration of the framing impulses to arrange that they alone drive the separator valve on to the sloping part of its characteristic curve, the other signals being confined to the flat-topped part of the curve.

As shown in the drawing, the incom-

Recent Inventions

ing signals are applied to the control grid of a pentode valve V through an input circuit C, R which has a time constant somewhat greater than the normal duration of a framing impulse. The grid of the valve is so biased, from a tapping on the potentiometer P, that the line impulses and picture signals produce only a negligible effect on the output current. On the other hand the framing impulses, by changing the operating point to a sloping part of the curve, are repeated in the anode circuit A and are

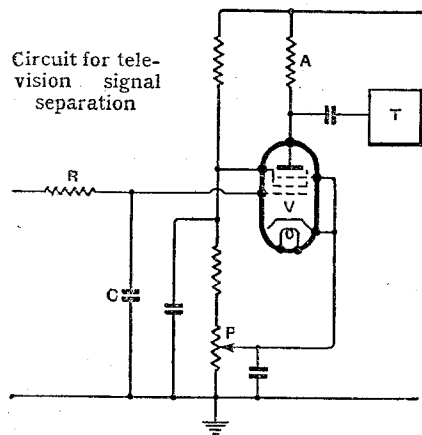

applied to the time base T. The circuit gives an "infinite" discrimination between the two sets of synchronising impulses, and allows the same valve to be used both as separator and amplifier.

Pye, Ltd.; W. Jones; and B. J. Edwards. Application date, April 22nd, 1938. No. 515302.

REMOTE TUNING CONTROL

AN endless band, strung over a pair of rollers, is marked on one margin with a station-indicator scale, and on the other margin with a series of equally spaced slots. A station-selector pointer is fixed to one edge of the endless band, and as it is moved into alignment with a desired station causes the slots to pass between a lamp and a photo-electric cell. The passage of each slot, therefore, creates a current impulse which is amplified and applied to operate a distant electro-magnetic relay.

The relay is geared to a ratchet wheel which is thus moved, step by step, through an angle corresponding to the movement of the station-selecting needle at the control point. The ratchet wheel, in turn, rotates the variable condenser, and so tunes the distant receiver to the desired programme.

Soc. Anon. Fimi. Convention date (Italy) July 22nd, 1937. No. 517033.

VOLUME COMPRESSION

RELATES to amplifying circuits in which the volume can be expanded or contracted at will, either to suppress undesired noise at low levels of volume, or to adjust the input of sound to a level

where it can best be amplified without distortion.

According to the invention, the output circuit of the amplifier is shunted by a potentiometer consisting of two resistances arranged in series. The first is a silicon-carbide element the resistance of which varies inversely with the current flowing through it, whilst the second is a constant resistance, which is small in value compared with the lowest resistance of the first element. A connection is taken from a point between the two series resistances to the grid of the amplifier, so that the voltage developed across the constant resistance is fed back in the negative sense to the input. The overall gain of the amplifier is large, and the amplification is effected at low voltage levels.

H. A. M. Clark. Application date July 16th, 1938. No. 516250.

FLUORESCENT SCREENS

IT is found that the pictures reproduced on the fluorescent screen of a cathode-ray television receiver are liable to be blurred owing to the accumulation of casual electric charges on the screen. These act to repel or divert the electrons forming the scanning beam, and so spoil the clearness of the picture at the points affected. The difficulty can be overcome by depositing the fluorescent material on a layer or grid of conducting material which serves to dissipate or equalise any local charges that may be set up.

With this object in view, the support or backing of the screen is first covered with a continuous thin layer of platinum, which is then partly removed by a cutter so as to form a number of transparent strips, the open parts of which are ten times wider than the residual metal. This makes a metal grid or network on which the fluorescent material is laid, the solid parts interfering only to a negligible extent with the luminescence of the screen as a whole.

Baird Television, Ltd.; A. K. Denisoff; and J. M. S. Spiers. Application date July 27th, 1938. No. 517427.

IMPROVEMENTS IN AMPLIFIERS

IN certain multi-stage amplifiers using negative feedback it is found necessary to reduce the phase shift at frequencies above and below the operating frequency, in order to prevent the production of harmonics and to ensure stability. The desired result can be obtained if the feedback resistance is supplemented by inductive reactance.

With this purpose in view the feedback resistance is accordingly wound into a coil having the necessary dimensions to introduce the required inductance; alternatively, the coil may be wound, on a former of the required size, and may be composed partly of resistance wire and partly of copper wire, so that the proportion of resistance to reactance may be accurately adjusted.

Standard Telephones and Cables, Ltd., and A. H. Roche. Application date July 1st, 1938. No. 516628.

TELEVISION MODIFICATION

INSTEAD of radiating the two sets of synchronising impulses on the same carrier wave, they are divided between the sound and vision channels. The frame impulses, for instance, are combined with the vision signals, one being used to modulate the carrier wave downwards from a given datum level, and the other upwards. This makes it possible to use the synchronising impulses both for the usual scanning purpose, and also for automatic volume control.

The line impulses are combined with the sound signals on the second carrier wave, the frequency being doubled, if necessary, to facilitate separation. For the same reason, the impulses may be arranged to cut the carrier down to zero, whilst the sound signals are prevented from doing so. In general, the arrangement ensures a more definite separation, and minimises the effect of electrical interference.

Baird Television, Ltd., and P. W. Willans. Application date May 11th, 1938. No. 514643.

AERIAL COUPLINGS

THE Figure shows an input circuit, which is particularly suitable for an aerial of small effective height, such as is used on a car. It is intended to give constant coupling over a wide range of frequencies, together with a high uniform gain. Provision is also made for balancing out any variations in the capacity of the aerial, and for ensuring the accurate alignment of all the tuned circuits in the set.

The circuit consists of an inductance L shunted by two capacities C and Cr arranged in series. It is tuned by moving a powdered-iron core P in and out of the coil windings in such a way as to maintain a constant ratio between the inductive reactance and the resistance of the circuit. The core is designed so that, as it is gradually inserted, the

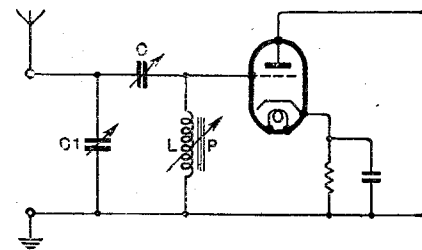

Input circuit arrangement for car aerials

total resistance increases as the first power of frequency, whilst the inductance increases inversely as the second power of frequency.

Any difference between the capacity of one aerial and another may be balanced out by adjusting the condenser Cr once and for all. The input circuit, as a whole, is then aligned with the other tuned circuits of the set by means of the second condenser C.

Johnson Laboratories Inc. (Assignees of F. N. Jacob). Convention date (U.S.A.), May 17th, 1937. No. 514641.

GOODMANS P.A. Loudspeakers for EVERY PURPOSE!

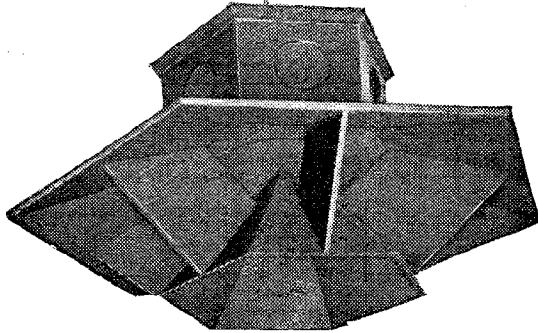

GOODMANS CONCENTRIC DIFFUSER
P.A. LOUDSPEAKER.

A compact high-power "quality" reproducer having non-directional properties. Due to its unique cellular construction exceptionally wide diffusion of high notes is obtained. Does the work of several standard loudspeakers—reduces interference due to echo effects.

Size : 36 x 18 ins. Power-handling capacity : 20 watts A.C. Peak. Impedance of speech coil : 15 ohms. **£19. 10. 0** Standard finish. Brown enamel.



GOODMANS DUPLEX HORN
P.A. LOUDSPEAKER.

Provides the ideal solution where directional properties are desired. Gives the effect of two horn loudspeakers set at an angle to each other. Wide angle diffusion at all frequencies.

Size : 2 ft. 10 in. long, 2 ft. 11 in. wide. Power-handling capacity : 15 watts A.C. Peak. Standard finish. Battleship Grey Lead Paint. **£5. 17. 0**

GOODMANS P12E & P12P.M. P.A. LOUDSPEAKERS
For really high quality reproduction. Capable of handling up to 20 watts A.C. Peak. These Instruments are characterised by clear-cut speech and full-bodied rendering.
P.M. Model **£7. 15. 0** Energised Model **£5. 3. 6.**

POST THIS COUPON
for booklet entitled "The Attainment of an Ideal," giving valuable information and data on the principles of Loudspeaker production. Attach to your card or letterheading.
WV740

GOODMANS INDUSTRIES, LTD., Lancelot Road, Wembley, Middx. Telephone : WEMbley 4001 (5 lines)

USE EDDYSTONE SHORT WAVE COMPONENTS



EDDYSTONE SHORT-WAVE H.F. Choke with patented low loss and connection D.L.-9 formers with spaced honeycomb wound coils. D.C. resistance 22 ohms. Inductance 1.25 millihenries. 5.150 metres. No. 1010. 2/2

EDDYSTONE New Type Microdensers with improved D.L.-9 insulation.
No. 1094. 18 m.mfd. high-voltage type. Min., 3 m.mfd. Max., 13 m.mfd. D.C. flash-over voltage, 3,500 volts. 4/3
No. 1129. 40 m.mfd. high-voltage type. Min., 3.5 m.mfd. Max., 40 m.mfd. D.C. flash-over, 2,300 volts. 4/9

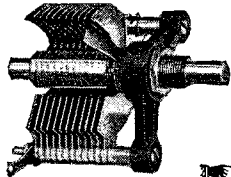

No. 1093. 50 m.mfd. D.C. flash-over, 2,300 volts. 4/11
No. 1131. 160 m.mfd. D.C. flash-over, 1,000 volts. 6/6

"EDDYSTONE" Pillar Insulators, made of glazed Frequentite and tested to a breakdown voltage of 30,000. In two types, one having a 2 BA fixing bolt and wing nut, the other a heavy duty plug and socket fitting with soldering tag connections.
No. 1049. 1/8
No. 1095. 1/10

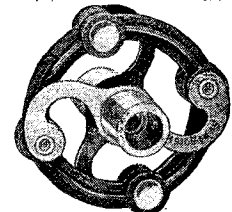

EDDYSTONE Flexible Coupler. Free from backlash but very flexible, this coupler banishes alignment troubles. D.L.-9 H.F. insulation. For 1/2 in. spindles. No. 1009. 1/8.



EDDYSTONE Extension Control Outfit made from precision drawn paxolin tube. Cannot warp or bend; insulating part 4 in. long. Brass insert 3 in. long. No. 1008. 1/5

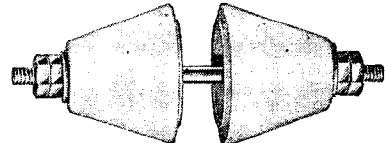

EDDYSTONE Frequentite Insulator for carrying H.F. leads through metal baseboards with minimum loss. No. 1013. 2/2



No. 1095

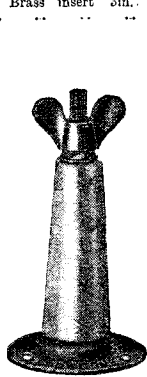

No. 1049

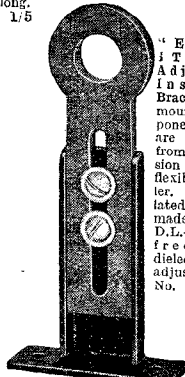

"EDDYSTONE" Adjustable Insulated Bracket for mounting components which are controlled from an extension spindle or flexible coupler. The insulated portion made from D.L.-9 high-frequency dielectric, is adjustable. No. 1007. 1/8

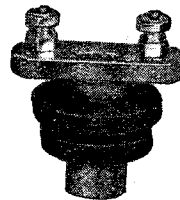

EDDYSTONE All-Wave H.F. Choke, low loss D.L.-9 former with two section honeycomb wound coils. One screw fixing. Wavering 12.5 to 2,000 metres. Self capacity 2.4 m.mfd. Inductance 17.9 millihenries. D.C. resistance 50 ohms. No. 1066. 2/2

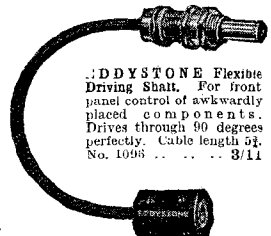

EDDYSTONE Flexible Driving Shaft. For front panel control of awkwardly placed components. Drives through 90 degrees perfectly. Cable length 32 in. No. 1095. 3/11

ORDER FROM YOUR DEALER—

EDDYSTONE

—OR WRITE OUR SERVICE DEPOTS.

STRATTON & Co. Ltd., BROMSGROVE STREET, BIRMINGHAM, 5.
London Service : **WEBB'S RADIO, 14, SOHO ST., W.1.** Birmingham Service : **WEBB'S, 41, CARRS LANE.**

Wireless World

CLASSIFIED ADVERTISEMENTS

THE CHARGE FOR ADVERTISEMENTS in these columns is

12 words or less, 3/- and 3d. for every additional word.

Each paragraph is charged separately and name and address must be counted.

SERIES DISCOUNTS are allowed to Trade Advertisers as follows on orders for consecutive insertions, provided a contract is placed in advance, and in the absence of fresh instructions the entire "copy" is repeated from the previous issue: 3 consecutive insertions, 5 per cent.; 6 consecutive, 10 per cent.; 12 consecutive, 15 per cent.

ADVERTISEMENTS for the August issue are accepted up to First Post on Wednesday, July 10th, at the Head Offices of "The Wireless World," Dorset House, Stamford Street, London, S.E.1, or one day earlier at the Branch Offices, 8-10, Corporation Street, Coventry; Guildhall Buildings, Navigation Street, Birmingham, 2; 260, Deansgate, Manchester, 3; 26a, Renfield Street, Glasgow, C.2.

Advertisements that arrive too late for a particular issue will automatically be inserted in the following issue unless accompanied by instructions to the contrary. All advertisements in this section are subject to prepayment.

Cheques and Postal Orders sent in payment for advertisements or deposits should be made payable to **ILIFFE & SONS Ltd.**, and crossed. Notes cannot be traced if lost in transit. They must therefore be regarded as being despatched at sender's risk. Alternatively, they may be sent per registered post.

All letters relating to advertisements should quote the number printed at the end of each advertisement and the date of the issue in which it appeared.

The proprietors are not responsible for clerical or printers' errors, although every care is taken to avoid mistakes. They also retain the right to refuse or withdraw advertisements at their discretion.

NEW RECEIVERS AND AMPLIFIERS

*

CHALLENGER RADIO CORPORATION.—We still lead with best value money can buy; send 2½d. stamp for illustrated catalogue of the finest all-wave receivers, handsome cabinets, speakers and valves; valves, firsts only, 6/- each; every article fully guaranteed; buy now.

CHALLENGER RADIO CORPORATION, 31, Craven Terr., Lancaster Gate, London, W.2. Pad. 6492. [9108]

COULPHONE RADIO, Ormskirk, for Ferguson, K.B., Decca, G.E.C., American Midgets. Full discounts. 2½d. stamp for quotation. [9077]

RADIOGRAMS, 8-valve all-wave 8-watt, £16; auto-radiograms, £20; sets from £1 to £100; 1½d. stamp secures list; part or complete exchanges.—Stewart and Roberts, Amersham. [9000]

BANKRUPT Bargains.—Brand new 1939-40 models, makers' sealed cartons, with guarantees, at less 30% to 40% below listed prices; also Midgets, portables, car radio; send 2½d. stamp for lists.—Radio Bargains, Dept. P.W., 261-3, Lichfield Rd., Aston, Birmingham. [9028]

£11 Only.—Usual price £22; *Wireless World* 2 R.F. Receiver with push pull quality amplifier, 10 valves, including tone control stage, 8 watts triode output, ideal for quality reproduction from radio and gramophone; limited number.—Bakers Selhurst Radio, 75, Sussex Rd., South Croydon. [9100]

COMMUNICATION RECEIVERS

DEMONSTRATION Sets, perfect condition, few hours use only; Denev DRX3, 6-bands, 8-500 metres, 6-valve superb, 12 gns.; DRX2, 4-band, 4-60 metres, acorn superhet, 7-valve, 13 gns.; new battery two, 3 to 180 metres, complete with valves and batteries, £4/17/6.—234, Burrs Rd., Clacton, Essex. [9082]

ARMSTRONG

TO OUR FRIENDS OVERSEAS

Many of you have bought our Standard chassis in the past but since the outbreak of war we have received an increasing number of enquiries for a chassis specially designed to meet the particular needs of our overseas friends.

We wish this could have been available to you months ago, but an Armstrong Chassis has got to be right and until we were fully satisfied on every detail of design, and tests proved it equal to the varying conditions under which it was to operate, we would not release it.

It is now in production and particulars are as follows:

SPECIAL OVERSEAS MODEL EXP43

8-v. 4-BAND ALL-WAVE SUPERHET CHASSIS

(13-160m. continuous & normal Broadcast bands)

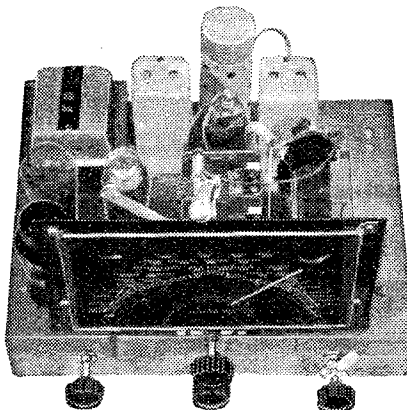

This chassis has been developed on the lines of our Model AW38 which has proved an outstanding success since its introduction at 1939 Radiolympia. Overseas requirements, however, have been given primary consideration. Firstly, an additional short-wave band has been incorporated and the chassis now gives an efficient continuous short-wave coverage from 13 to 160 metres. All coils and I.F. transformers have been specially treated to render them impervious to humidity. Switching is of extra robust construction and contacts heavily plated. The mains transformer is interleaved and has a generous iron content to avoid excessive temperature rise and the steel chassis itself is heavily cadmium plated for 8 gns. tropical use. International standard base valve-holders are used throughout. Plus 5%

With 8" P.P. Speaker **£9.9.0** Plus 5%
With 10" P.P. Speaker **£10.3.0** } war increase

OVERSEAS TRADE BUYERS

are invited to get into touch with us.

For our friends at Home

OUR ILLUSTRATED ART CATALOGUE fully describes the above new model, our well-known AW125 PP (reviewed so favourably by "The Wireless World"), the SS10 and all other chassis in the Armstrong range. Write for your copy to-day—6d. p.f.

ARMSTRONG MANUFACTURING CO.

WARLTERS RD., HOLLOWAY, LONDON, N.7, ENGLAND.

Phone: NORth 3213.

For the convenience of private advertisers, letters may be addressed to numbers at "The Wireless World" Office. When this is desired, the sum of 1/- to defray the cost of registration and to cover postage on replies must be added to the advertisement charge, which must include the words Box 000, c/o "The Wireless World." All replies should be addressed to the Box number shown in the advertisement, c/o "The Wireless World," Dorset House, Stamford Street, London, S.E.1. *Readers who reply to Box No. advertisements are warned against sending remittances through the post except in registered envelopes: in all such cases the use of the Deposit System is recommended, and the envelope should be clearly marked "Deposit Department."*

DEPOSIT SYSTEM

Readers who hesitate to send money to advertisers in these columns may deal in perfect safety by availing themselves of our Deposit System. If the money be deposited with "The Wireless World," both parties are advised of its receipt.

The time allowed for decision is three days, counting from receipt of goods, after which period, if buyer decides not to retain goods, they must be returned to sender. If a sale is effected, buyer instructs us to remit amount to seller, but if not, seller instructs us to return amount to depositor. Carriage is paid by the buyer, but in the event of no sale, and subject to there being no different arrangement between buyer and seller, each pays carriage one way. The seller takes the risk of loss or damage in transit, for which we take no responsibility. Details of any arrangement made between parties which does not concur with any of the above conditions must be advised to us when the deposit is made. For all transactions whether a sale is effected or not a commission of 1 per cent. is charged on and deducted from the amount deposited (minimum charge 2/-). All correspondence must be sent to Dorset House, Stamford Street, London, S.E.1.

COMMUNICATION RECEIVERS

Wanted

PHILIPS 352, H.M.V. 650, similar or communication receiver.—Holden, "Sixstreams," Weston Bath. [9084]

COMMUNICATION Receiver, test equipment; full particulars.—Watt, 23, Petrie Cres., Elgin, Morayshire. [9099]

COMMUNICATION Receiver, National H.R.O., R.M.E., Hammarlund, Hallcraft; S.X.16.—Hardwicke, 29, Warwick Av., Crosby, Lanes. [9070]

USED SETS FOR SALE

EDISTONE

EDISTONE All-world Two Short Wave, as new; 42/-.—Westwood, High St., Grays. [9076]

ARDEnte

ARDEnte 20-watt Amplifier, 2 speakers, microphone; £9.—99, Lofting Rd., N.1. [9056]

PYE

PYE International, 8 bands, 6 watts, bandspread; £12/10; new, genuine sacrifice.—Box 2524, c/o *The Wireless World*. [9093]

SCOTT

SCOTT Imperial, with Expander, 27 valves, chassis, amplifier, speaker, perfect; £40.—A.C.S. Radio, 46, Widmore Rd., Bromley. [9067]

WAYFARER

BARGAIN.—Perfect Wayfarer 4v. battery portable; £1.—Jackson, "Cartref," Rowe Ave., Peacohaven. [9096]

W.W. MONODIAL

"W.W." Monodial twin chassis, 25w. output, many refinements, complete; £5.—Luckes, 24, Rootery Rd., Bristol, 4. [9069]

TRANSFORMERS & CHOKES
By
PARTRIDGE
a
guarantee in itself

Firms experiencing difficulty in obtaining transformers from their usual source of supply should get into touch with us at once.

We are still living up to our reputation for prompt and personal service.

We are also open to consider sub-contracts for limited quantities.

N. Partridge

King's Bldgs., Dean Stanley St., London, S.W.1.
 Phone - VICTORIA 5035

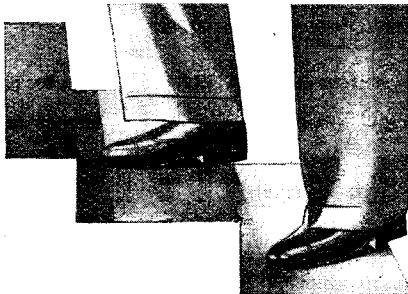

Another Step

.....toward better record reproduction has been achieved with our experimental MOVING COIL PICK-UPS.

Equipment for measuring needle restoring force has now been developed to give consistency and eliminate the small peak at 130 c/s shown in the W.W. review (June, p. 301). The reduced treble is deliberate.

Speed up of production should enable us to supply by end of July those experimental pick-ups ordered before the end of May.

Further deliveries in rotation but with priority for export.

If you want an outstanding pick-up place your order now. Advance information ready.

PICK-UP with corrector, anticipated price £6. Output low but results 'satisfy' the extra valve necessary.

VOIGT PATENTS LTD.
 THE COURTS · SILVERDALE · S.E.26
 TELEPHONE: SYDENHAM 6666
 Regd. Office: 22, Castle Street, E.C.1.

USED SETS FOR SALE

MISCELLANEOUS

SALE of Radiograms, receivers, etc., from £1 to £100, new or used; part or complete exchanges; 1½d. stamp for bargain list.—Stewart and Roberts, Amersham. [9001]

Wanted

SUPERHET, short-wave converter, complete or components.—Particulars, Galloway, Marlborough Gardens, Carlisle. [9109]

WANTED, "Wireless World" feeder unit for 12-watt amplifier. ("W.W.," April 3rd and 10th, 1936.)—Widdup, Reedham, Poynton Park, Poynton, Cheshire. [9057]

PUBLIC ADDRESS

ARDENTE Velocity Microphone, 600 ohms, cost 15 gns., unused, £8; Partridge transformer, 7/6 extra.—Taylor, The Nook, Bradway, Sheffield. [9064]

30 Watt Amplifier, complete with twin turntables. Piezo pick-ups, six speakers and horns, Igranite microphone and stand, etc.; £30.—W. Flower, 623, Lea Bridge Rd., E.10. Keystone 4218. [9081]

VORTEXION P.A. Equipment

IMITATED, but unequalled.

WE Invite You to a Demonstration.

A.C.-20 15-20-watt Amplifier, 38-18,000 cycles, independent mike and gram, inputs and controls, 0.037 volts required to full load, output for 4, 7.5, and 15 ohms speakers, or to specification, inaudible hum level, ready for use; 8½ gns. complete.

C.P. 20 12-volt Battery and A.C. Mains Model, as used by R.A.F., output as above; 12 gns.

A.C.-20, in portable case, with Collard motor, Piezo pick-up, etc., £14; C.P.20 ditto, £17/17.

50-WATT Output 6L6s, under 60-watt conditions, with negative feed back, separate rectifiers for anode screen and bias, with better than 4% regulation level response, 20-25,000 cycles, excellent driver, driver transformer, and output transformer matching 2-30 ohms impedance electronic mixing for mike and pick-up, with tone control, complete with valve and plugs; £17/10.

COMPLETE in Case, with turntable, B.T.H. Piezo pick-up and shielded microphone transformer; £22/10.

80-WATT Model, with negative feed back; £25, complete.

120-WATT Model, with negative feed back; £40, complete.

250-VOLT 250 m.a. Full Wave Speaker, field supply unit; 25/-, with valve.

WE are Compelled Through Rising Costs to Increase our Prices by 10%.

ALL P.A. Accessories in Stock; trade supplied.

SEE Our Display Advertisement on page 343 (Edit.).

VORTEXION, Ltd., 182, The Broadway, Wimbledon, S.W.19. Phone: Lib. 2814. [9090]

NEW MAINS EQUIPMENT

VORTEXION Mains Transformers, chokes, etc., are supplied to G.P.O., B.B.C., L.P.T.B.; why not you?

WE are Compelled Through Rising Costs to Increase our Prices by 10%.

VORTEXION, Ltd., 182, The Broadway, Wimbledon, London, S.W.19. Telephone: Liberty 2814. [9091]

ALL-POWER TRANSFORMERS, Ltd.—Transformers and chokes to specification, rewinds; write for quotation.—89, Gladstone Rd., Wimbledon, S.W.19. Liberty 3333. [9110]

NEW LOUD-SPEAKERS

COULPHONE RADIO, Ormskirk, for Rola speakers, energised. P.M. See advertisement under components. [9078]

ELECTRADIX BARGAINS

Signal Training Aids for Navy, Army and R.A.F. SERVICE SIGNALLERS

L.R. DOUBLE HEADPHONES, 120 ohms, with all leather headbands, slide adjustment chin strap and 4ft. cord. Comfortable, 3/9.
 L.R. SOLO PHONES. For use with buzzer Morse. Useful as a circuit tester with a pocket cell. Single Earpiece, 40 ohms, metal hook loop, with cord, 1/3. Ditto, D.3, 60 ohms, with cord, 1/6. W.E. 1,000 ohms, with cord, 2/-, 2,000 ohms Earpiece, with cord, 2/6.
 HIGH RESISTANCE RADIO PHONES. Brown's A reed diaphragm swivel headband, 4,000 ohms, 35/6. 1,500 ohms, 21/6. 120 ohms, 17/6.
 Headphones—Various. Second-hand Headphones, in good order, 2,000 ohms and 4,000 ohms, 5/-, 6/6 and 7/6, with cords. Western Electric, 2,000 ohms, 5/6.

PORTABLE FIELD PHONES FOR LISTENING POSTS AND A.R.P. Leather cased W.D. Type 135. Service Field Phones are difficult to get at the present time, but we have some soiled but serviceable and can give immediate delivery. Pig-skin cases, Morse keys, mike and phone.
 EXCHANGES. Ping type, 5 line and 20 line. SHELTER PHONES and operators exchanges. Wire and cables cheap.
 EDISON STEEL STORAGE CELLS. TYPE AS AT LOW PRICES.

A.R.P. SHELTER Ventilation and Air Conditioning. Compact unit, A.C. or D.C. mains, 80 watts; 5in. Blower, 20 cub. ft. fresh air per min. 25/- is a bargain price.
 WET WEATHER ELECTRIC PUMPS, for A.C. or D.C. 12v. to 230v. Centrifugal all bronze pump, throws 120 gals. per hour, 72/6. Type R pumps. Twin piston type for draining shelters, 26/17/6.
 MORSE KEYS. Service Keys now available are all soiled and well used. We have both Army and Navy types. We also have a range of other keys. Service Silent Practice Keys 3/-. T.X. Practice Key, front contact, on black moulded base, a good small key, 3/6. Long Bar Type Practice Key, T.X.2, with cranked bar, 5/6. Superior model B.2, with back contact, a well finished key on polished wood base, 7/6. Operators' T.F.E. plated pivot bar and terminals, mahogany base, 9/6. Type L.V. Superior ditto, nickel-plated pivot bar and fittings, on polished base, 10/6. Panel Keys to fold up flat, 6/6. Fullerphone double acting Morse Box with Morse key for code signals, 4/6. S. G. Brown totally enclosed type, 42/-.

LEARNERS' MORSE PRACTICE SET. Special Duplex with Key Buzzer and Lamp for sound and visual, 10/-. Hellographs and tripod.
 BUZZERS, small type, with cover, 1/6. Power Buzzers, with screw contact and adjustable armature, 2/6. Heavy Buzzers, in Bakelite case, 3/6. Siemens Morse Line Transmitter, with key and driver, casual Power Buzzer, 17/6. Magneto Exploders, 25/-. Field Telegraph Sets with Sounder, Relay and Galvo, etc.
 MORSE INKERS Tape Strip Recorders: portable or table. Dot-dash or Wheatstone. Cheap. Wheatstone Strip Hand Perforators, 15/-. Paper Tape for Morse and Wheatstones, green or white, 6d. rec'. Brass Tape Reels in mahogany case, 2/6.
 TESTERS. Field A.C. or D.C. Vest Pocket Tester "Dix-Mipanta" Bakelite case, 2/4in. by 3in. No projecting terminals. Universal versatile high grade, moving-iron multi-range meter for service on A.C. or D.C. battery or mains. Three ranges of volts: 0-7.5 volts; 0-15 volts; 0-300 volts. 19/6 only.
 METERS. Lineman's Q.I. & Galvos. Two ranges: with three terminals for circuit testing. 15/-. Horizontal Silver-tone Galvos, 7/6.
 CELL TESTERS. Megger 3-0-3 volts moving coil, 17/6.
 ELLIOTT BATTERY TESTERS. Government Model 108. Moving Coil Ammeter and graded rheostat, 27/6.
 METERS MOVING COIL. Full size, moving coil, P.M., for adapting home-made multi-range testers. For 5in. or 4in. dials, 5/-. post 1/-. ALUMINIUM FOIL 12in. by 12in., 9d. sheet.
 LABORATORY METERS. Nalder sub-standard mirror scale moving coil, 20 m.v. per div., as new, 65/-. Unipivot, Cambridge and Paul, def. 3 microamps. per div. Paul Frequency meter, scaled 50-600 periods. Panel Frequency meters, 100 cycles, 50/-; 60 cycles, 45/-. G.Z. Megger Voltmeters, 17/6. Capacity Bridges to 10 mfd. cheap, D.C. Wattmeters, 35/-.
 GALVOS. Type "G" bridge-galvo, suspen. needle, 20/-. Tunley Ballistic suspen. Mirror, 23. Gambrell, ditto, vert., brass case, 44. Sullivan Marine Reflecting, fine, 24. Plug types, portable, G.P.O., 27/10. Silver-tone, 23. 2 1/2" type 4-dial, cheap. Universal Shunts, 15/-. Reversing Keys, etc., cheap.
 BARGAIN CINE PROJECTORS. Powers No. 6, 35 mm. Dallmeier lens and condenser, motor drive, on stand with 'antenn and arc, 26/10/-, worth double. Sound head with head Amplifier, 28.
 15-DAY TIME SWITCHES. Vanner 1 amp, 5 amps, 100 amps, 200 amps. From 21/-.
 THERMOMETERS. Panel 2in. dial, 5ft. ether tube, for distant indicating, reading 0 to 100 deg. Cent., 7/6. Cambridge, 10/6.
 FOURNIER THERMOMETERS, by Cambridge Instrument Co. 4in. dial, 10-110 deg. Cent. Fitted adjustable electric contacts, 25/-.
 FUSES. Glass tube, 1 amp, 6d. With clips and base, 9d.
 PUSH BUTTON TUNING. 6-way Gang Push, metal cover, 1/6. Multiple Cord, 6d.
 STATIC CONVERTERS. A.C. mains to D.C. 40 watts output, steel cased. Output 400 volts, 60/100 m.a. D.C. with valves, 45/-. A.C. mains to D.C. 120 volts at 1/2 amp, for 220 v. D.C. sets, steel-cased, valves, 50/-.
 5/- EMERGENCY PARCELS of useful stand-by electrical and radio repair material and apparatus, 10 lbs. for 5/-. Post Free.
 Stamped envelope must be enclosed for Bureau List or for v.p.t.s. to inquiries.

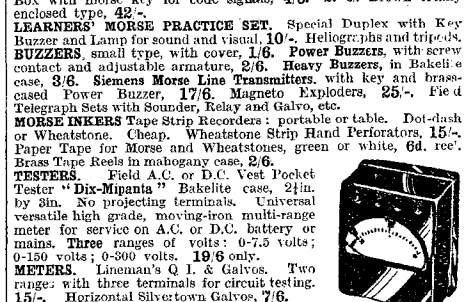

Key, solid brass on heavy base, 7/6. Three-colour light flash enclosed type, 42/-.

ELECTRADIX RADIOS
 218, Upper Thames Street, London, E.C.4
 Telephone: Central 4611



MCCARTHY
The Chassis Specialists

THREE NEW RECEIVERS

available in Chassis form
or complete in Cabinet
for those who desire

Individuality and Reliability

- R.S. 640 - - - £9.17.6
- P.P. 840 - - - £12.12.0
- P.P. 940 - - - £15.15.0

Cabinets - - - from £12.10.6
Matched Speakers from £1. 5.0

Write for Illustrated Brochure giving full details and specifications, enclosing 2½d. for postage.

H. MCCARTHY LTD. (C. H. S. Smith
Receiver and Manager)
Clarendon Works, Montague Street, Worthing,
Sussex.

**ARE YOU FIT—
for High Speed CODE work ?**

Speed and Accuracy in code work is only obtained by those who train both their mind and body. The better your health the greater your progress. This important side of training is fully covered by the Candler System "Advanced" Code Course.

For further details see pages 4 and 5 of the Candler "Book of Facts." Fill in the Coupon below and get a copy free. Particulars of other courses also given in this book.

Read these extracts from letters recently received from Candler students who are "speeding up" their w.p.m.
"I have been making steady progress with the Course. I am now, with a little concentration, able to receive code at a speed of 20 to 22 w.p.m. My sending speed is about 20 w.p.m."—A.T.
"Perhaps you may think it a little strange wanting to study this as I am already a radio op., but I met one or two other sea-going ops. who had greatly improved themselves and who recommended the Candler course."—J.H.M.
"My CW is now better than ever it was and can manage to take 16-17 w.p.m. Have just received lesson 5. If the improvement continues at the present rate, I'll be doing 30 w.p.m. by the time I get lesson 10."—W.G.
(Original letters can be seen on request.)

ADVANCED High-Speed Telegraphing for operators who want to increase their w.p.m. speed and improve their technique.

JUNIOR Scientific Code Course for Beginners. Teaches all the necessary code fundamentals scientifically.

TOUCH-TYPEWRITING for making one expert in the use of the typewriter for recording messages.

Courses supplied on Cash or Monthly Payment terms.

COUPON

Please send Free Copy of Candler "Book of Facts," to—
NAME.....
ADDRESS.....

Post Coupon in 1d. unsealed envelope to London Manager
CANDLER SYSTEM CO. (Room 55W),
121, Kingsway, London, W.C.2
Candler System Co., Asheville, North Carolina, U.S.A.

NEW LOUD-SPEAKERS

BAKERS Brand New Surplus Speaker Bargains.

EVERY Music Lover Interested in Realistic Reproduction should write for free descriptive leaflet now.

£8 Only; usual price £16.—Brand new corner horn speaker, frequency range 30-12,000 cycles.

£4/10; usual price £10.—Brand new permanent magnet infinite baffle speaker, complete with beautifully finished cabinet in polished walnut.

£2/7/6; usual price £5.—Brand new super magnet model; exceptional bargain; limited number.

SECURE One of These Exceptional Bargains Now.

BAKERS SELHURST RADIO, 75, Sussex Rd., S. Croydon. [9101]

SECOND-HAND LOUD-SPEAKERS

Wanted

WANTED. Rothermel Crystal "Tweeter" R.155, good condition.—Box 2522, c/o *The Wireless World*. [9065]

EXTENSION SPEAKERS

27/6 usual price £3/5.—Brand new Infinite Baffle Extension speaker in cabinet, limited number.—Bakers Selhurst Radio, 75, Sussex Rd., Croydon. [9103]

TELEVISION

H.M.V. All wave 1939 Console Televisor, £25; Baird T5C 12in. Console Televisor, £25; Eye Table Televisor, £18.—A.C.S. Radio, 46, Widmore Rd., Bromley. [9066]

SHORT-WAVE EQUIPMENT

FARREX Universal Mains Converter, new; 25/— Box 2528, c/o *The Wireless World*. [9107]

DENCO.—Ultra low loss S.W. components, receivers, polystyrene insulation; send 2d. for catalogue.—Warwick Rd., Clacton, Essex. [8960]

G5NI to Short Wave Equipment; largest stocks in the country; communication receivers; National agents; American and British Valves, etc. See advertisement on page 2.—44, Holloway Head, Birmingham. [0531]

"H.A.C." One-valve Short-wave Receiver, famous for over 5 years, now available in kit form; complete kit of precision components, accessories, full instructions, 12/6, post 6d., no soldering necessary; descriptive folder free on request.—A. L. Bacchus, 109, Hartington Rd., S.W.8. [9085]

CABINETS

A CABINET for Every Radio Purpose.

SURPLUS Cabinets (Undrilled) from Noted Make.

WE Have Hundreds in Stock (no Catalogues); send measurements of chassis, etc., and say what kind of cabinet required; stamp for reply.

INSPECTION Invited.

H. C. SMITH and Co., Ltd., 289, Edgware Rd., W.2. Tel.: Pad. 5891. [0485]

DYNAMOS, MOTORS, ETC.

ALL Types of Rotary Converters, electric motors, battery chargers, petrol-electric generator sets, etc., in stock, new and second-hand.

A.C. D.C. Conversion Units for Operating D.C. Receivers from A.C. Mains, 100 watts output, £2/10; 150 watts output, £3/10.

WARD, 46, Farringdon St., London, E.C.4. Tel.: Holborn 9703. [0518]

VALVES

ALL Types of American Tubes in Stock of Impex and Arcturus makes at competitive prices.

WE Can Also Supply a Full Range of Guaranteed Replacement Valves for Any British non-ring, American or Continental type at an appreciably lower price.

SEND for Lists of These, and also electrolytic condensers, line cords, resistances, etc.

CHAS. F. WARD, 46, Farringdon St., London, E.C.4. Tel.: Holborn 9703. [0452]

COULPHONE RADIO, Ormskirk. — Guaranteed American valves, 4/6; Octal, 5/6. Guaranteed British types, 40% discount. [9079]

METROPOLITAN RADIO SERVICE.—American valves, in all types, trade supplied.—1021, Finchley Rd., N.W.11. Speedwell 3060. [0436]



Constant heat makes neat efficient work

With ordinary soldering when the iron cools you get unsightly blobs of solder, wasteful and insecure. Change to Solon Electric Soldering! No stopping to heat up the iron. Once hot, and that takes only 4 minutes, the Solon stays hot—all the while you need it. It's simple, quick, cheap. 15 hours use for 1 unit. No coal grit—no soot; you get cleaner, stronger, joints with the Solon.

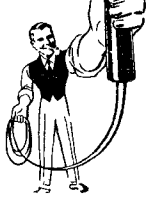

Made for following standard voltages:—200/220, 230/250.



Supplied complete with Resin-Cored Solder, Flex and Lamp Adaptor **9/4**

Solon Resin-Cored Solder **6d.** per reel.

W. T. HENLEY'S TELEGRAPH WORKS CO. LTD.
(Dept. 15/E) Engineering Sales Dept., Gravesend, Kent.

JUST PUBLISHED

TELEVISION RECEIVING EQUIPMENT

By

W. T. COCKING, A.M.I.E.E.
of

"The Wireless World,"

Author of *Wireless Servicing Manual*

This new handbook contains comprehensive information for everyone interested in Cathode ray receiving equipment. The treatment is substantially non-mathematical although design formulae has been included, where necessary, largely for reference.

PRICE 7/6 NET By Post 8/-

Published by
LILFIE & SONS LTD.,
DORSET HOUSE, STAMFORD STREET,
LONDON, S.E.1

METERS, ETC.

FERRANTI Moving Coil 2½-dial one milliampere. unused; 25/-;—Box 2526, c/o *The Wireless World*. [19105]

TEST EQUIPMENT

TEST Oscillator Kit, due to supply restrictions, release postponed until September.
INTERIM List of Standard Kits (multimeters, bridges etc.), Ferranti meters and future releases on request.—Maclachlan and Co., Strathyre. [19055]

WANTED, all types.—Particulars. Radio Service Co., 225, Eversleigh Rd., London, S.W.11. [19018]

AVO Oscillators, two only, condition as new, original cost £6; offered to clear at £3/10 each.—Hunt, 21, Douglas St., S.W.1. [19071]

RESISTANCE Boxes, Wheatstone bridges, meggers, all-resistive voltmeters, microammeters, milliammeters, etc.; state requirements.—Newmans, 7, Russell Chambers, Bury Place, Bloomsbury. [19111]

COMPONENTS

SECOND-HAND, CLEARANCE, SURPLUS

RADIO CLEARANCE, Ltd.,
63, High Holborn, W.C.1. Phone: Holborn 4631.

LISSEN 2v. Screen-grid Valves, S.G.215 and S.G.2V, 4/6 each.

LISSEN 2v. Battery Pentode, 4-pin side terminal P.T.2A and P.T.225, 4/11 each.

LISSEN 4v. Mains Screen Grid, A.C./S.G.; 5/11 each.

LISSEN 4v. Mains Output Pentode A.C./P.T.; 5/11 each.

LISSEN Rectifier Valve V650; 2/11 each.

ALL-WAVE Superhet Chassis, 5v. A.C., latest Mullard valves, T.H.4.B., V.P.4.B., T.D.D.4., Pen. A.4., L.W., 4/350v.; ranges, short-wave 16-48 metres, medium wave 200-550 metres; long wave 800-2,200 metres; size of chassis, 14½ in. long, 7½ in. deep, height overall 8½ in.; controls, tuning at side; volume on/off at side, wave-change, provision for pick-up; complete with valves and knobs, £4/10; special speaker, 1,500 ohms-field, 10/6 each.

ULTRA Short and Short-wave Choke, Lissen Hi Q, inductance 100 microhenries; boxed, list, 2/-; our price, 1/- each.

ULTRA Short and Short-wave Double Wound Low-resistance choke; Lissen Hi Q resistance less than 0.5 ohms; boxed, list, 2/6; our price, 1/3 each.

LOW-LOSS Ceramic Valve-holders, Lissen Hi Q, baseboard and chassis, 5- and 7-pin; 10d. and 1/- each.

MANSBRIDGE Type Condensers, Lissen Hi Q, 250 V.D.C. working, moulded case with feet 0.1 in. and 1 mfd., 6d. each.

ROTARY Coil Unit.—Lissen Hi Q four-band from 4.8-91 metres, can be selected by a turn of the knob, with circuit; boxed, list, 15/6; our price, 6/11 each.

LOW-LOSS Short-wave Variable Condensers, Ceramic insulation, brass vanes, Lissen Hi Q, minimum capacity 5 micro-micro farads; two types, boxed, with knobs, 160 m.mfd.; list, 7/6; our price, 3/- each; 20 m.mfd., list, 5/6; our price, 2/6 each.

NONE Speaker Unit, Lissen, complete with reed and chuck, boxed; 1/- each.

PUSH-PULL Switches, Lissen; 2-point, 4d. each, 3-point, 6d. each.

ROLA P.M. Speakers, latest type, 7½ in. cone with power and pentode transformer, boxed; 15/- each.

CLOCK-FACED Dials, 5in. x 3½ in., with printed 3-wave scale, ox-copper escutcheon and glass, 3/6 each; ditto, less escutcheon, 2/6 each.

FILAMENT Transformers, input 200-250v., output 4v. 4 amps., 4v. 6 amps.; 4/11 each.

MAINS Transformers, Plessey, 350-0-350v., 90 m.a., 4v. 2.5 amps., 4v. 6 amps.; 8/6 each.

MAINS Transformer, G.E.C., American windings, 350-0-350v., 65 m.a., 5v. 2 amps., 6.3v. 2.5 amps., suitable for replacements in G.E.C. models; 5/6 each.

MAINS Transformers, Wearite, type R.C.1, 250-0-250v., 80 m.a., 4v. 2.5 amps., 4v. 4 amps., 9/11 each; type R.C.2, 350-0-350v., 120 m.a., 4v. 2.5 amps., 4v. 4 amps., 12/6 each; type R.C.3, 350-0-350v., 150 m.a., 4v. 2.5 amps., 4v. 2 amps., 4v. 5 amps., 15/- each; type R.C.4, 500-0-500v., 150 m.a., 4v. 2 amps., 4v. 2 amps., 4v. 2.5 amps., 4v. 5.6 amps., 21/- each; all above are centre-tapped windings; type R.C.5, 100-watt auto transformer, 100-110v., 200-250v., reversible, 12/6 each; all transformers 200-250v. tapped primaries.

(This advt. continued in 3rd column.)

GALPINS
ELECTRICAL STORES
75, LEE HIGH ROAD, LEWISHAM,
LONDON, S.E.13
Telephone: LEE GREEN 5240

Terms: Cash with Order

EPOCH P.M. MOVING-COIL SPEAKERS, 10in. cone, 10 ohm speech coil, handle 10/12 watts, 32/6 each. Carriage, 2/6.

MAGNAVOX P.M. PUBLIC ADDRESS HORN SPEAKERS, handle 16/20 watts. Size of horn, 40in. by 20in. flare, 55/- each. Carriage forward. Packing, 2/6 extra. Ditto, two only, Western Electric, 25/- each, C.F.E. 2/6 extra for packing.

MOVING-COIL METER MOVEMENTS for recalibrating into multi-range meters. Low milliarh deflection, 2½in. dial. Makers: Everett Edgumbe and other good makers. Price, 6/- each.

EX-G.P.O. PEDESTAL TELEPHONES, complete with automatic dials, 8/6 each; without dials, 6/- each. Bell Boxes, complete with A.C. bell, microphone, transformer, condenser, etc., 3/6 each. Hand Combined Telephones with finger press switch, 4/6 each.

ELECTROSTATIC (EVERETT EDGUMBE) VOLTMETER, 0 to 6,000 volts, sin. dial, in new condition, 62/6, C.F.

PUBLIC ADDRESS 8-10 WATT AMPLIFIERS, 200/240-volt A.C. mains using 2PX's in parallel, less valves, 32/6 each, carriage 2/-.

HIGH-VOLTAGE TRANSFORMERS, useful for all test work or television. Input 200/240 volts, output 5,000 and 7,000 volts output 6/6 each, post 1/-.

MAINS TRANSFORMERS, 200/250 volts input, 12 and 24 volts at 4/6 amps. output, suitable for model trains, etc., 15/- each, post 1/-.

MAINS TRANSFORMERS, 200/240 volts input, 50 volts 8 amp. output, useful for small arcs, etc., 15/- each, post 1/-.

RAYGRAFT MAINS RELAY UNIT, complete with 10,000 ohm relay mains transformer, rectifier, condensers, etc., 12/6 each, post 1/-.

PUBLIC ADDRESS HORNS for sin. speakers, size 40in., with 30in. flare (non-metallic), 30/- each.

A.C. INDUCTION MOTORS, approx. 1 h.p., 1,440 r.p.m., 200/240 volt 50 cy. 1-phase. New condition, 27/6 each.

EX-G.P.O. GLASS-TOP RELAYS, with platinum points, new condition, 10/- each, post 6d.

ELECTRO DYNAMIC D.C. TO A.C. ROTARY CONVERTERS, 240 volts D.C. input, 230 volts 50 cy. 1 ph. 100 watts output. Complete in silence-proof cabinet with all smoothing. Condition as new, 95/- each, C.F.

VOLTAGE CHANGING TRANSFORMERS (Auto Wound), 100/110 to 200/240 volts or vice versa. Guaranteed 12 months. 250 watts, 25/-; 500 watts, 32/6; 1,000 watts, 50/-; 1,500 watts, 62/6. Delivery 7 days from date of order.

STUART TURNER 2½-H.P. PORTABLE ENGINE, Petrol, twin flat air-cooled, complete with all accessories, in good condition, 27/10/-, C.F.

DYNAMOS, for charging or lighting, etc., all shut wound and fully guaranteed. 100-volt 10 amp., 4-pole, 1,500 r.p.m., 90/-; 50/75-volt 15 amp., 1,750 r.p.m., 4-pole, 90/-; 20-volt 10 amp., ball bearings, 1,500 r.p.m., 4-pole, 70/-; 25-volt 8 amp., 1,750 r.p.m., 2-pole, ball-bearing, 37/6; 50/75-volt 25 amp., 4-pole, 1,500 r.p.m., 110/-.

ELECTRIC LIGHT CHECK METERS, for sub-lettings, garages, etc., 200/250 volts, 50 cy. r.h., supply 10 or 20 amps., 6/- each, post 1/-.

TRUXOV PUBLIC ADDRESS HORN SPEAKER UNITS, 15-ohm. speech coil, 6v. fil., 15/- each, post 1/6.

X-RAY TUBES, 4 to 7in. bulbs, tungsten targets, 15/- each; platinum targets, 25/- each, 2/6 extra for packing, C.F.

PHILIPS PRE-STAGE AMPLIFIERS, Consisting of 4 x 4 mf. 750-volt condenser, 400-volt transformer, L.F. choke, less valves, 10/- each, C.F.

WESTON MOVING-COIL MILLIAMP METERS, 0 to 50 mA., 2in. dial model (506), as new, 20/- each. Ditto, 301 model, 0 to 3 mA., 30/- to 50 mA., 25/-.

PORTABLE LIGHTING ENGINES, 2½-twin Douglas, special air cooling, complete with all fittings, including petrol tanks, etc., fully protected, condition as new, £10, C.F.

WESTINGHOUSE L.T. RECTIFIER, 6 volts 1 amp., with main transformer to suit, 11/6 the pair.

EX-NAVAL ONE-VALVE BUZZER WAVEMETERS, 200/240,000 meters. Makers: Sullivan. Type K.5. 10/6 each, C.F.

EX-NAVAL 2in. SPARK COILS, 12-volt working, complete, 25/- each, post 2/- (P.O. permit required.)

SMALL ELECTRIC ROTARY CONVERTOR, 110 volts D.C. input, 10 volts at 30 amps. output. Useful for graving; charging, 55/-, C.F.

ROTARY CONVERTORS, all in good condition, 100-volt D.C. input 120-volt 1 amp., 338 cycles output, 35/-. Another, 24-volt D.C. input, 100-volt 3 amps 500 cycles output, 45/-. Another, 24-volt input, 600 volt, 100 m.a., 600 cycles output, 45/-. All c/f forward.

X-RAY TRANSFORMERS, input 120 volts 50 cy., 1 phase, 4,000 volt 80 v. output, 27/10/-. Another, same input, 64,000 volts 2 kva output, £11/10/-. Carriage forward.

50-VOLT D.C. MOTORS, ½ h.p., 1,500 r.p.m., 6/6 each. Ditto, 100 volt D.C., 7/6 each.

ZENITH VARIABLE RESISTANCES single-bar type, 5,000 ohms, carry 300 m.a., 25/-; Ditto, 1,100 ohms at 6 amps., 20/-; Ditto, twin-bar type, 180 ohms, carry 6.5 amps., 30/- each.

PHILIPS MAINS TRANSFORMERS, 200/240 volts input, 2,000/0 2,000 volts 200 m.a. output, with two L.T. windings, 35/- each, C.F.

MAINS TRANSFORMERS, 200/240 volts input, 100 volt 40 m.a. and 4 v. 1 amp. output, 4/6 each. I.F.

D.C. MOTOR BLOWERS, 2in. inlet and outlet. Aluminium body, laminated field, ideal for dug-out ventilation. 100-volt, 25/-; 220-volt, 30/-, C/F/d.

E.C.C. DYNAMO, 50/75 volts, 40 amp., 1,500 r.p.m. Ball-bearing. In good condition, 27/10/-, c/f forward.

EX-G.P.O. SMALL RELAYS, 1,000 x 1,000 ohms with multi contacts, new, 5/-; Ditto, 7,000 ohms two-leave type, 3/6 each. Useful for remote con. rol, etc.

COMPONENTS—SECOND-HAND, CLEARANCE, SURPLUS, ETC.

(This advt. continued from 1st column.)

CHASSIS Mounting Valve-holders, American 4-5-6-7-pin, 4d. each; Octals, 6d. each; Locals, 10d. each; 7-pin English type, 3d. each.

1-WATT Resistances, Polar N.S.F., 4d. each; 3/9 dozen; all sizes up to 2 meg.

VOLUME Controls, American C.T.S., finest made, divided spindles, length 2½ in., with switch 2,000, 5,000, 10,000, 25,000, 100,000, 250,000, 500,000 and 1 meg., 2/6 each; wire wound 5-watt (less switch), 2,000, 5,000, 10,000, 20,000 and 25,000 ohms., 2/- each.

24 MFD. Can Type Electrolytics, 450v. working; 1/6 each.

MAINS Transformer, type R.C.D. drop through, capped 250-350c. 100 m.a., C.T. 4v. 6 amps., 4v. 2.5 amp., wire ends; 10/6 each.

SPEAKER Transformers, pentode output, 3-4 ohm, matching; 3/- each.

10 ft. Coils, glazed connecting wire; 4d. coil.

B.I. Wire-end Type, bias electrolytics, 50 mfd., 12v., 1/6 each; ditto, 50 mfd., 50v., 2/- each.

TUBULARS, wire-end, non-inductive paper condensers; all sizes up to 0.1, 5d. each, 4/9 dozen.

8x8x8 Hunts 450v. working Cardboard Electrolytics, 3/11 each; 16x8 350v. working ditto, 2/11 each.

B.I. 8x8 mfd., 550v. working, cardboard electrolytics, 3/6 each; ditto, 16x8 mfd., 4/6 each; ditto, 8 mfd. tubulars, 2/- each; ditto, 4 mfd. tubulars, 1/9 each; ditto 2 mfd. tubulars, 4/300v. working, 3/3 each

ALL Orders Must Include Sufficient Postage to Cover. Hours of business: 9 a.m.-6 p.m. week-days, 9 a.m.-1 p.m. Saturdays.

PLEASE Write Your Address in Block Letters.

WE Cannot Undertake to Answer Enquiries Unless Accompanied by Full Postage (2½d.).

RADIO CLEARANCE, Ltd., 63, High Holborn, London, W.C.1. Telephone: Holborn 4631. [19086]

PREMIER RADIO.
PLEASE See Our Displayed Advertisement on page 5. [19438]

SOUTHERN RADIO'S Bargains.
ALL Guaranteed; postage extra.

5/- Parcel of Useful Components, comprising condensers, resistances, volume controls, wire, circuits, etc., value 25/-; 5/- per parcel.

15/-—Service man's component kit; electrolytic condensers, volume controls, resistances, tubular, mica, paper condensers, valve holders, etc., 120 articles, contained in strong carrying case, 9in. x 7in. x 7in.; 15/- the kit.

5/-—100 wire end resistances, assorted capacities, ½ and 1 watt; 5/- per 100.

ORMOND Loud Speaker Units, 2/6; Westectors, type W2, 2/6; Crystal Detectors, 2/-; Crystals, 6d.; Marconi V2A Valves, 3d.

2/-—Tool or instrument carrying cases, ex Government stock; wood 9in. x 7in. x 7in.; 2/-.

SOUTHERN RADIO, 46, Lisle St., London, W.C. Gerrard 6653. [19113]

NEW H.M.V. Quality Pickup, cost 105/-; sacrifice, 30/-; New Telefunken 1,000; 25/-; W.W. Transverse mike; 30/-;—Box 2527, c/o *The Wireless World*. [19106]

NUMBER Shop Soiled S.W. Components, etc., also new valves; send for list.—Denco, 234, Burrs Rd., Clacton, Essex. [19083]

VAUXHALL—Rola G12 and other type speakers, Magnavox speakers, Coliaro gramophone motors, radiogram units, available.

VAUXHALL—Electrolytic condensers, cardboard, 8 mfd. 500 v., 2/-; 8 plus 8 mfd., 3/6; 50 mfd. 50 v., 1/9; 50 mfd. 12 v., 1/6; metal can, 8 mfd. 500 v., 3/-.

VAUXHALL—Tuning coils, bar-type condensers, full vision drives, stocked; volume controls, 2/-; with switch 3/-; pick-ups from 11/-.

VAUXHALL UTILITIES, 163a, Strand, London, W.C.2.—Stump for price list above goods. [19097]

MAINS RADIO DEVELOPMENT Co. Regret to announce suspension of their service for Duration, owing to partners taking up R.A.F. flying duties; their super service will resume as soon as the war is won. [19089]

5/- Only.—Bargain parcel comprising speaker cabinet, drilled steel chassis, condensers, resistances, and many other useful components, worth 35/-; limited number; postage 1/-.—Bakers Solihull Radio, 75, Sussex Rd., South Croxdon. [19104]

COMPONENTS—SECOND-HAND,
CLEARANCE, SURPLUS, ETC.

RYALL'S RADIO, 280, High Holborn, London, W.C.1, offer new goods, post free.

ELLIPTICAL Speakers, Celestion, suitable Ekco replacements, 750 ohms, less transformers, speech 25 ohms, new, handle 8 watts, carry up to 120 m.a.; 3/9 each, to clear.

FERRANTI Air Core Type Tuning Coils, transformer wound, can be used as band pass, tuned grid with reaction, chassis type; three for 2/6, with coil connections.

T.M.C. 0.5 mF Paper Tubular Condensers, N.L., 400v., D.C. working, 3 for 1/3; Erie 60 ohm 1/2 watt resistances, 1/3 dozen; Erie 1,500 2-watt resistances, 4 for 1/3; 600 ohm wire wound, 3 watt, 4 for 1/3.

VOLUME Controls.—Morganite Stackpole 1/2 meg., with switch 1/9; Murphy 1/2 meg. type with D.P. switch, 1/9; Sator broad base type without switch, 10,000 and 250,000 ohm, 1/3 each; Centralab 11,000 short spindle, less switch, two for 1/3; Sator midget, less switch, 1 meg. and 0.4 meg., 1/2 each, or two for 1/9.

THIMBLE Top Caps, 30 for 1/3; 9-pin plugs with cap and socket, two for 1/6; Epicyclic (reduction) drives, two for 1/3; Erie 5-watt resistances, 0.25-270-300-350-400-15,000-60,000 2 meg., two for 1/3.

4-WAY Lead in Single Core, brown or white, single strand, 4 yards 1/3; push back connecting wire, stranded, 12 yards 1/3; Polar dials, less escutcheon, 2 band, 1/6, V.P. type, ideal instrument for P.A. work under all conditions.

SPEAKERS—Celestion, energised types, 7,500 and 2,000 ohms, less transformer, 8in., 5/6 each; 600 ohm ditto, 6in., 5/-; Magnavox 2,000 ohm, with pentode transformer, 8/6.

SPECIAL Offer 2v. British Base Type Valves, triodes only, H.F. det., G.P. power, super power, similar to Triotron, all types, 2/- each; American 6G5 tuning eyes, 2/9.

ELECTROLYTICS—T.C.C. 8 mF. wet type 802 upright cans, 440v. working, 460v. surge, 1/9 each, 15/9 dozen; T.C.C. midget block electrolytics, 25x25v. and 10 mF. at 150v., 1/3 each, three for 2/9.

SPEAKERS—Pairs elliptical cone M.C. speakers, Plessey and R. & A., ex Philco, push-pull pentode transformer, fields 325 ohm for smoother, 8,600 ohm as bleeder, handle 10-15 watt, 10/9 pair.

GOLDTONE Mains H.F. Chokes, 120 watt, 2 for 1/6; Plessey midget semi screened twin gangs, 2/9, Plessey twin gangs, screened, with trimmers, 2/6.

AMERICAN Type 2v. Valves (1A4, 1B4 2101), in sets three, VM/HF/Pen., HF/Pen., and 1/2 watt output pentode, with valve base circuit and details, 4 and 5-pin, with top grids, 5/9 set three; valve holders, chassis, to suit, three for ninepence.

AMPLIFIER Kit Parts for 12-watt output, single 6L6 output, V.H., etc., mounted on chassis, 10x7, complete with four valves, pair Celestion elliptical speakers, resistances, condensers, tone and volume controls, and comprehensive circuit, 3 stage high gain, fully tested, for A.C. 200-250 volts; 45/-, carriage 2/6 extra.

BEST Known Make, 1 watt, colour coded carbon resistances, 20 sizes, as ordered; 2/6 dozen; 1/2 watt type, 2/- dozen.

ASSORTED Resistances, 50 for 2/6; 1 watt carbon, U.S.A. make, reasonable assortment given, sizes approx. 450-12,000-17-60-70-90-120 thousand ohms.

PANOLIN Strip for Group Boards, etc., 2 1/2 in. wide, 3ft. for 1/3; Centralab 1/2 meg. and 50,000 ohm pots, with switch, long spindles, 2/6.

ULTRA Type Brown Knobs, octangle, plain arrow, U.L.S., 1/9 dozen, 8/6 gross assorted, 10/6 gross plain or arrow.

SMALL Iron Core Coils, made by Varley, aerial and oscillator, 485 k/c, 2/6 pair, with coil connections for straight type gang.

FERRANTI Wire Wound 2 1/2 watt Resistances, with metal end caps, tubular, sizes 3,000, 4,000, 6,000, 8,000, 35,000; four for 1/3.

CLIX Valve Holders 4- and 5- and 7-pin, square and oblong, 1/3 dozen; chassis types, 4- and 5- and 7-pin, round type, with cover, 2/6 dozen.

REX Type Switches, 4B, 2P, 4w., with shorting plates on 5 switches, 2/6; 4B, 2P, 3w., 1/6; 2B, 4P, 5w., 1/3; screens, 3 1/4 x 3 1/2, 5 for 1/3.

PLESSEY 3-gang Fully Screened Straight Type Condensers, with top trimmers, 2/9; Plessey 3-gang straight type, all wave, ceramic insulators with SM cord drive, antimicro feet, 2/9.

T.C.C. Tubular 8 mF. Dry Type 450v. Electrolytics, wire ends; 1/6 each, 12/9 dozen. [9114]

COULPHONE RADIO, Ormskirk.—Collaro A.C. gramophone motors, 12in. turntable, 27/6. Radiogram units, 45/-, Cosmocord Series III crystal pickups, 18/6. Rola G12 speakers, with transformers, energised 1.250 or 2,500 field, 52/6. G.12 P.M., 65/- Service components. 2/d. stamp for lists. [9030]

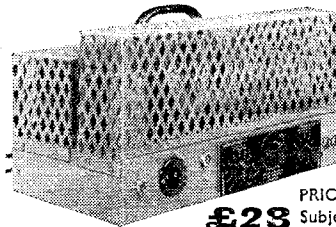
The C25
ACOUSTICAL
AMPLIFIER30 Watts Output
from 12v. Battery or A.C. MainsPRICE
£23 Subject

Low Battery Consumption

The Output is obtained from a pair of KT 66 valves operating in paraphase Push-Pull under 32 watt conditions. A High Standard of Quality at 30 watts, combined with the fact that the equipment operates direct from a 12-volt car battery or A.C. mains, plus the features detailed below, makes this the ideal instrument for P.A. work under all conditions.

- Dual inputs for high and low impedance lines, electrically mixed at Driver stage.
- Four high gain stages all R.C. coupled.
- Variable output impedance.
- Automatic polarising for low impedance input.
- H.T. and silencing switch for economy in consumption.
- Tone control, portability, etc.

Write for full Specification and Circuit.

EXPORT Overseas Buyers are invited to write for our favourable Export Terms.

The ACOUSTICAL MANFG. CO.
Electro-Acoustic Engineers
201-205, Lever Street, City Road, London, E.C.1.
Tel.: CLERkenwell 5821.

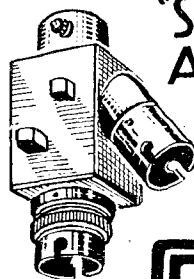
"SAFEWAYS"
ADAPTORS

The modern dual purpose fitment for radio or other domestic electrical appliances.

Plugs into any lampholder.

CLIX

British Mechanical Productions Ltd.
1, Church Rd., Leatherhead, SurreyL.R.S. for all Quality Radio
& Electrical Apparatus

CASH or EASY TERMS

ARMSTRONG CHASSIS Model SS10
Cash or C.O.D. £13.4.0 or 45/- with order
and 10 monthly payments of 23/-.
Model AW38 Cash or C.O.D. £8.16.6 or
45/6 down and 7 monthly payments of 20/-
also.

Ambassador Chassis and Receivers, Sound
Sales Amplifiers, Voigt Speakers, Avo
Meters and Portable A.R.P. Receivers.

Write TO-DAY for Particulars and Terms

The Evacuation address Est. 1925
LONDON RADIO SUPPLY COMPANY
"Winden," Ardingly Road, Balcombe, Sussex

MISCELLANEOUS

CARDS, memos., billheads; 1,000, 6/9; samples. Rubber stamps.—"B", Tices, 11, Oaklands Grove, London, W.12. [9075]

EVERY Radio Dealer Who is Not a Regular Reader of "The Wireless and Electrical Trader" should send his trade card at once for a specimen copy and full details of the "Trader" Services. "The Wireless and Electrical Trader" has the widest influence, the largest weekly circulation, and is read by all the leading manufacturers and traders. Trade only. 15/- per annum, post free. Published at Dorset House, Stamford St., London, S.E.1. [0615]

REPAIRS AND SERVICE

"EPOCH"—Genuine replacements. Service. Spares. Repairs.—"R.E.C.S.," Crown St., Reading. Phone: 2796. [9094]

GUARANTEED Repairs, any transformers, choke, motor, armature, converter, dynamo, etc.; keenest prices, immediate quotation, prompt, dependable service.—See below.

L.T.P. LONDON TRANSFORMER PRODUCTS, (Ltd.), Willesden, N.W.10 Willesden 6486 (3 lines). [6892]

MAINS Transformer Service, repairs, rewinds, or construction to specification of any type, competitive prices and prompt service.—Sturdy Electric Co., Dipton, Newcastle-on-Tyne. [0516]

"SERVICE with a Smile."—Repairers of all types of B-British and American receivers; coil rewinds; American valves, spares, line cords.—F.R.I., Ltd., 22, Howard St., W.1. Museum 5675. [8934]

METROPOLITAN RADIO SERVICE.—Guaranteed repairs to American and British receivers; American valves, service parts and rewinds; trade supplied.—1021, Finchley Rd., N.W.11. Speedwell 3000. [9435]

HOOVER, £4/10 (accessories included); also Electrolux, £4/4. Hotpoints, Tellus, Vactrics, Goblins, from 49/6. All completely serviced. Guaranteed perfect.—"R.E.C.S.," Crown St., Reading. Phone: 2796. Generous allowance for your old cleaner. [9095]

REPAIRS to Moving Coil Speakers; cones/coils fitted or rewound; fields altered or wound; prices quoted, including eliminators; pick-ups and speaker transformers rewound, 4/6; trade invited; guaranteed satisfaction; prompt service.—L. S. Repair Works, 5, Balham Grove, London, S.W.12. Battersea 1321. [0394]

SITUATIONS VACANT

AIR MINISTRY.

DIRECTORATE OF SIGNALS (CIVIL AVIATION).

APPLICATIONS are invited for Appointments as Civilian W/T Operators at Air Ministry Civil Aviation W/T Stations. These appointments are of a temporary nature in the first instance, but it may be possible to absorb a proportion of temporary posts into the permanent establishment after the conclusion of hostilities.

APPLICANTS, who should not be above 45 years of age at the date of making the application, should preferably possess the 1st Class Postmaster-General's Certificate or the Air Operator's Certificate in Wireless Telegraphy, and have had experience in radio-telephony, direction-finding and maintenance work. Operators will be required to serve at any Air Ministry Civil Aviation station, as the needs of the service may require.

SALARY is at the rate of 75/- a week for the first two years, thereafter rising by annual increments for approved service to a maximum of 125/- a week.

THE Normal Hours of Duty are 45 a Week, exclusive of meal times, day or night, or 180 on periods of four weeks.

ARRANGEMENTS will be Made for Suitable Candidates to be interviewed at Renfrew, Manchester, London or Bristol.

REQUESTS by Postcard for Forms of Application should be addressed to the Under-Secretary of State, Air Ministry (E.L.e), Julian Rd., Bristol, 9, and should state the town at which an interview is desired. [9063]

PLANNING Engineer for Radio Valve Factory, North London.—Write, stating age, salary and experience, to General Manager, Box 2529, c/o Wireless World. [9112]

SERVICE Engineer for Valve Deaf Aids, London, W.1., age 18-30; reserved occupation; good prospects.—Write experience, age, salary required, Box 2525, c/o Wireless World. [9098]

DRAUGHTSMEN (over and under military age) for radio circuits, chassis layouts, diagrams, etc.; good technical knowledge essential.—Box B, Parr's Service, 121, Kingsway, W.C.2. [9092]

for PERFECT PORTABLE POWER

Masteradio

MALLORY

VIBRAPACKS & VIBRATORS

Any Output Range up to 300 volts at 100 m/a from 6 or 12 volts. Also 150 watts A.C. from 110 or 220 volts D.C.

3 out of 4 Vibrators in use throughout the World are Mallory made.

Send for technical data.

MASTERADIO Ltd.

Vibrant Works, 193, Rickmansworth Rd., Watford, Herts.

Telephone: Watford 9885/9890
Telegrams: Mastiola, Watford

Greenwood

SITUATIONS VACANT

AIR MINISTRY.—Civilian Wireless Instructors Required.

VACANCIES exist for Civilian Wireless Instructors at the Electrical and Wireless Schools, Royal Air Force. The commencing rate of pay is £4/5 a week, inclusive, which may be increased to £4/10 a week after a short period of satisfactory service. Candidates must be capable of lecturing and must have a sound knowledge of electrical principles and their application to radio and low-power electrical engineering. Applications should be addressed to the Under-Secretary of State (S.S.d.), Air Ministry, Kingsway, W.C.2, giving particulars as to previous experience, age, etc. Suitable candidates will be required to appear before a Selection Board at the School for interview and trade test, but may be reimbursed the cost of third class travelling expenses for this purpose. The test will include the giving of a lecture on any subject which may be chosen by the candidate involving the principles of modern radio. Lecturing sequence and style are most important. [0616]

THE Sudan Government invites applications for the post of Wireless Inspector in the Posts and Telegraphs Department.

CANDIDATES should be between 24 and 32 Years of Age (preferably 26); qualifications as follow:—

(A) Practical Knowledge and Experience in the Installation, testing out, maintenance and running repairs of:

MEDIUM and Short Wave Wireless Transmitters up to 6 kW. Wireless receiving sets and direction finding equipment.

INTERNAL Combustion Engines, including Diesels.

GENERATORS, DC and AC, up to 25 kW.

CELLS (all types) and Charging Equipment.

(B) A sound knowledge of Wireless Theory.

(C) Experience in Rigging Aerials and Erecting Masts of Various Types.

THE Post is a Pensionable One, but on five years' probation, with entry to Scale E.2 at £E324-360 per annum, according to age and qualifications, rising to £E600 by three or two biennial increases and three triennial increases. (£E1=£1 0s. 6d.)

FURTHER Particulars may be obtained from the Controller, Sudan Government, London Office, Wellington House, Buckingham Gate, London, S.W.1, to whom applications should be submitted not later than the 27th June, 1940. Envelopes should be marked "Wireless Inspector." [9087]

EXPERIENCED Instrument Makers Required, rate 1/8 to 2/- per hour for 48 1/2 hr. week.—Apply Employment Dept., Murphy Radio, Ltd., Welwyn Garden City, or nearest Employment Exchange. [8828]

ARMSTRONG Co. Require a Radio Engineer; modern experience essential; good remuneration and rapid advancement offered.—Phone: North 3213, or write, Armstrong Mfg. Co., Warblers Rd. (Nags Head), Holloway, N.7. [9115]

RADIO Valve Works Require Assistant Foreman; must have knowledge of radio valve assembly and exhaust, and have experience of supervision.—Apply, stating salary required, to Cosmos Manufacturing Co., Ltd., Brimsdown, Enfield. [9073]

RADIO Testers and Inspectors Required for Day and night work, with experience of receivers and/or transmitters and associated equipment.—Write, stating age and experience, to the Plessey Co., Ltd., Vicarage Lane, Ilford, Essex. [9059]

RADIO Testers Required, applicants must have had technical training and experience of receiver circuit trimming on factory production lines.—Apply Employment Dept., Murphy Radio, Ltd., Welwyn Garden City, or nearest employment exchange. [8820]

UNIVERSITY Graduate (of British nationality) in Physics or Engineering Required for communications laboratory.—Write, stating age, education, experience and salary required, to Employment Office, Siemens Brothers and Co., Ltd., Woolwich, S.E.18. [9061]

RADIO Technician Required as Commercial Radio Manager by large accessory manufacturing group; must be thoroughly introduced to radio designers and have unquestionable standing in industry.—Fullest particulars and salary required, Box 2523, *The Wireless World*. [9072]

SITUATIONS WANTED

SERVICE Engineer, first-class certificate City and Guilds radio service work, is in position to assist traders with servicing.—Write: D. Ellis, 121, Kingsway, Petts Wood, Kent. [9088]

MORSE EQUIPMENT

FULL Range of Transmitting Keys, practice sets, oscillators, recorders and other radio Telegraph apparatus, designed and manufactured by T. R. McElroy, world champion telegraphist. Sole distributors, Webb's Radio, 14, Soho Street, London, W.1. Phone: Gerrard 2089. [8768]

WARD
AC/DC ROTARY CONVERTERS

for operating P.A. amplifiers, Radio Receivers, etc.

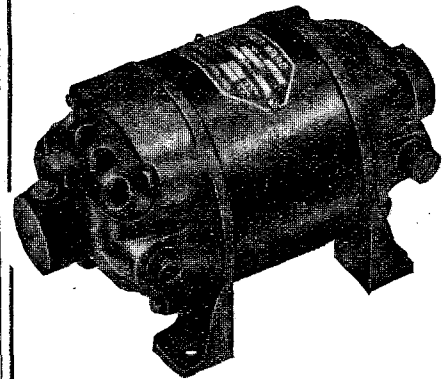

WE ALSO MANUFACTURE

DC/DC ROTARY TRANSFORMERS, SMALL ALTERNATORS, SMALL DC MOTORS, H.T. GENERATORS, MAINS TRANSFORMERS up to 10 k.v.a. PETROL ELECTRIC generator sets up to 50 k.v.a. BATTERY CHARGERS for private and industrial use, and are fully equipped for general small engineering work. Full details of any of the above upon request. Export enquiries invited.

CHAS. F. WARD

46, FARRINGTON ST., LONDON, E.C.4
Telephone: Holborn 9703. Works: Bow, E.

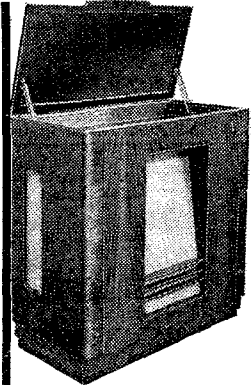

The **LOCKWOOD AD 500**

Still the finest **RADIO-GRAM CABINET**

Send 2 1/2d. in stamps for full details.

All orders dealt with in strict rotation.

LOCKWOOD & CO. 65, LOWLANDS RD., HARROW, MIDDX.

Phone: EYRon 1818.

TRIX

RELIABLE AMPLIFICATION
The TRIX ELECTRICAL COMPANY LTD.
65, Bolsover St., London, W.1. Euston 5471

SOUND EQUIPMENT

MOTORCYCLE

Every Thursday 4d.

W.W.15



FOR THE

RADIO SERVICE MAN, DEALER AND OWNER

The man who enrolls for an I. C. S. Radio Course learns radio thoroughly, completely, practically. When he earns his diploma, he will KNOW radio. We are not content merely to teach the principles of radio, we want to show our students how to apply that training in practical, every-day, radio service work. We train them to be successful!

INTERNATIONAL CORRESPONDENCE SCHOOLS

Dept. 38, International Buildings, Kingsway, London, W.C.2.

Please explain fully about your Instruction in the subject marked X.

Complete Radio Engineering
Radio Service Engineers

Elementary Radio Television

If you wish to pass a Radio examination, indicate it below.

Inst. of Wireless Technology
P.M.G. Certificate for Wireless Operators
Provisional Certificate in Radio Telephony and Telegraphy for Aircraft
City and Guilds Telecommunications

Name..... Age.....

Address.....

(Use penny stamp on unsealed envelope.)

PATENT AND TRADE MARK AGENTS

GEE and Co. (H. T. P. Gee, Mem. R.S.G.B., etc.) 51-52, Chancery Lane, London, W.C.2. Holborn 4547 8. Handbook free. [0001]

BUSINESSES & PROPERTY FOR SALE, TO BE LET, OR WANTED

"THE Wireless and Electrical Trader" is an essential part of the equipment of every Wireless Trader; its pages reflect the very latest turn of trade events, and it is read by all the leading dealers and manufacturers, for particulars of businesses offered or wanted. By subscription, to the trade only, 15/- per annum, post free. Send your trade card for specimen copy to Dorset House, Stamford St., London, S.E.1. [0614]

TECHNICAL TRAINING

WARTIME Engineering Training with The T.I.G.B. is Your Best Investment. Write to-day for Great Free Guide which shows how to qualify for well-paid posts in aeronautical, automobile, chemical, mechanical, electrical, telecommunications, etc., branches, and alone gives the regulations for A.M.I.R.E., A.M.Inst.C.E., A.M.I.Mech.E., A.M.I.E.E. A.F.R.Ae.S., A.M.I.Chem.E., C. & G., etc., in which examinations T.I.G.B. students have gained 22 first places.

THE TECHNOLOGICAL INSTITUTE OF GREAT BRITAIN, 82, Temple Bar House, London, E.C.4 (Founded 1917.) [9058]

PATENTS FOR SALE

THE Proprietor of British Patents Nos. 426,227 and 426,228, relating to "Improvements in or relating to Radio Signalling," is desirous of entering into negotiations with one or more firms in Great Britain for the purpose of exploiting the invention, either by sale of the patent rights or by the grant of licences on reasonable terms. Interested parties who desire further particulars should apply to Albert L. Mond and Thiemann, of 14-18, Holborn, London, E.C.1. [9068]

TRIPLE CONE CONVERSIONS

BAKERS Triple Cone Conversions Will Immensely Improve Reproduction of Your Present Speaker. ("For a few shillings you have converted a speaker scheduled for the scrap heap into one worth pounds.—W. E. Darby. Grad. I.E.E.")

SPECIAL Offer.—We will loan you a speaker free of charge whilst we fit a triple cone to your present unit; write for details.

BAKERS SELIHURST RADIO, 75, Sussex Rd., 5th Creydon. [9102]

THE COIL PICKUP

is now in production and deliveries of this superlative instrument are being made in rotation.

INCLUSIVE PRICE £7-10-0

Place your order now.

H. H. JONES,

62, Worcester Street, STOURBRIDGE

ELECTRADIX

EMERGENCY ELECTRIC LIGHTING

Provide against failure of lighting in shelters, headquarters, homes and factories. Have your own Petrol Electric Lighting and Charging Plant.

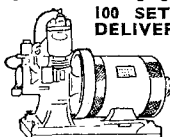

100 SETS READY FOR IMMEDIATE DELIVERY. Half kilowatt and other sizes.

FOR £17.10.0 ONLY. A 500-watt, single cylinder 2-stroke, water cooled, self-oiling Stuart Turner engine; mag. ign., coupled to 50/70 volts, 10 amps. shunt dynamo, 1000 r.p.m., £17.10.0. No increase in price; these are

£40 sets ready for immediate delivery. FOR £13. A 150-watt Engine and Dynamo on similar lines but coupled to 25/30 volts, 6 amps. dynamo.

EDISON Steel Cells, Type A8, cheap.

LESLIE DIXON & CO.

Electrical Engineers,

218, UPPER THAMES STREET, LONDON, E.C.4

Telephone: Cent'ral 4611

LEONARD HEYS for prompt and careful attention to RADIO DEALERS' WANT-LISTS. 36, Henry Street, Blackpool, Lancs.

Send us your trade card for our interesting Catalogue and ask us to mail you our Monthly Bulletins.

Our Postal Service covers the British Isles. Wholesale only.

LEONARD HEYS, Faraday House, 36, Henry Street, Blackpool, Lancs.



Mains Transformers to customers' own specifications, or in accordance with our standard list—of which we would be glad to send you a copy.

W. BRYAN SAVAGE LTD.

Westmoreland Rd., London, N.W.9. Phone: Colindale 7131

CLASSIFIED ADVERTISEMENTS intended for the AUGUST ISSUE can be accepted up to Wednesday, July 10th.

TUITION

RADIO Training.—P.M.G. exams and I.E.E. Diploma; prospectus free.—Technical College, Hull. [0611]

RADIO Officers (Marine), P.M.G. Special Certificate; free prospectus.—Marine School, South Shields. [8225]

MORSE Code Courses.—"Book of Facts," free.—Candler System Co. (Room 55.WO), 121, Kingsway, London, W.C.2. [9074]

PRACTICAL Postal Courses, radio television, test equipment design, trade-test coaching for R.A.F. post, I.P.R.E. and I.W.T. exams; booklet free.—Secretary, I.P.R.E., 3, Shirley Rd., London, W.4. [8838]

BOOKS, INSTRUCTION, ETC.

NEW Edition, American Amateur Relay League Handbook. 500 pages of up-to-the-minute technical information, 7/-, post 6d. 1940 JONES Handbook; approximately 700 pages dealing with every aspect of short-wave radio, 8/6, post 6d.—Webb's Radio, 14, Soho St., London W.1. Phone: Gerrard 2089. [8765]

WEBB'S Radio Map of the World Enables You to Locate Any Station Heard. Size 40in. by 30in. 2-colour heavy art paper, 4/6, post 6d. Limited supply on Lnen, 10/6, post 6d. Webb's Radio Globe, superb 12in. full-colour model. Radio prefixes, zones, etc. Heavy oxidised mount. Post paid, 27/6.—Webb's Radio, 14, Soho St., London, W.1. Phone: Gerrard 2089. [8767]

"FOUNDATIONS of Wireless." By A. L. M. Sowerby, M.Sc. Second Edition. An elementary textbook on receivers. Deals fully with the construction of wireless sets, valves, and the process of detection. Price 4/6 net. By post 4/11, from Iliffe and Sons Ltd., Dorset House, Stamford Street London, S.E.1.

"RADIO Data Charts." By R. T. Beatty, M.A., B.E., D.Sc. Second edition. A series of Abacs providing most of the essential data required in receiver design and enabling problems to be solved without having recourse to complicated mathematical formulae. Price 4/6 net. By post 4/10, from Iliffe and Sons Ltd., Dorset House Stamford Street, London, S.E.1.

"ELEMENTARY Principles of Wireless Telegraphy and Telephony." By R. D. Banguay. Revised by O. F. Brown, B.Sc. Third edition (1930). The standard textbook for wireless students and beginners. Deals with the whole subject of wireless telegraphy and telephony, avoiding too technical a treatment of the problems involved. Well illustrated. Price 7/6 net. By post 8/-, from Iliffe and Sons Ltd., Dorset House, Stamford Street, London, S.E.1.

THE INSTITUTE OF WIRELESS TECHNOLOGY

(Founded in 1925. Incorporated 1932)

PROFESSIONAL MEMBERSHIP

The advantages of professional membership are open to all qualified wireless engineers.

Full information, with syllabus, may be obtained from the Assistant Secretary, Institute of Wireless Technology, 25, Fins Drive, Palmers Green, London, N.13. Phone: PALMERS GREEN 2413

INDEX TO ADVERTISEMENTS

Table listing advertisements and their page numbers: Acoustical Mfg. Co. (14), Armstrong Manufacturing Co. (10), Automatic Coil Winder & Electrical Equipment Co., Ltd. (1), Birmingham Radiomart G5N1 (2), British Institute of Engineering Technology (8), British Insulated Cables, Ltd. (Inside Back Cover), British Mechanical Productions, Ltd. (14), British Rola, Ltd. (4), Bulglin, A. F., & Co., Ltd. (Edit. p. 341), Candler System Co. (12), Dixon (Leslie) & Co. (16), Electradix Radios, Ltd. (11), Elite Radio (2), Erie Resistor, Ltd. (Inside Back Cover), Erskine Laboratories, Ltd. (Inside Back Cover), Fittoa, R. N., Ltd. (4), Fluxite, Ltd. (Edit. p. 339)

Table listing advertisements and their page numbers: Calpin's Electrical Stores (13), General Electric Co., Ltd. (6), Goodmans Industries, Ltd. (9), Henleys, W. T., Telegraph Works Co., Ltd. (12), Hers., Leonard (16), H.M.V. (Back Cover), Institute of Wireless Technology (16), International Correspondence Schools (15), Jones, H. H. (16), Lockwood & Co. (15), London Radio Supply Co. (14), Masteradio, Ltd. (15), McCarthy, H., Ltd. (12), McClure, John, Ltd. (4), M.R. Supplies (4), Partridge, N. (11), Peto Scott Co., Ltd. (7)

Table listing advertisements and their page numbers: Pitman, Sir Isaac, & Sons, Ltd. (Edit. p. 355), Premier Radio Co. (5), Radio Clearance, Ltd. (Classified 13), Ryall's Radio (Classified 14), Savage, W. Bryan, Ltd. (16), Siemens Elec Lamps & Supplies, Ltd. (2), Simmonds Aeroelectronics, Ltd. (3), Southern Radio (Classified 13), Stratton & Co., Ltd. (9), Telegraph Condenser Co., Ltd. (Inside Front Cover), Trix Electrical Co., Ltd. (The) (15), Voigt Patents Co. (11), Vortexion, Ltd. (Classified 11 & Edit. p. 343), Ward, C. F. (15), Webb's Radio (Edit. p. 355), Whiteley Electrical Radio Co., Ltd. (Inside Back Cover)

Printed in England for the Publishers, ILIFFE AND SONS LTD., Dorset House, Stamford Street, London, S.E.1, by THE CORNWALL PRESS LTD., Paris Garden, Stamford Street, London, S.E.1. "The Wireless World" can be obtained abroad from the following: FRANCE: W. H. Smith & Sons, 248, Rue Rivoli, Paris; Hachette et Cie, Rue Racanur, Paris; and branches; Messageries Dawson, 4, Rue de Fauborg Poissoniere, Paris. AUSTRALIA: Gordon & Gotch, Ltd., Melbourne (Victoria), Sydney (N.S.W.), Brisbane (Queensland), Adelaide (S.A.), Perth (W.A.), and Launceston (Tasmania). NEW ZEALAND: Gordon & Gotch, Ltd., Wellington, Auckland, Christchurch and Dunedin. INDIA: A. H. Wheeler & Co., Bombay, Allahabad and Calcutta. CANADA: Imperial News Co., Toronto, Winnipeg and Vancouver; Benjamin News Co., Montreal; Gordon & Gotch, Ltd., Toronto. SOUTH AFRICA: Central News Agency, Ltd.; Wm. Dawson & Sons (S.A.), Ltd., Cape Town. UNITED STATES: The International News Co., New York.

B.I. COPPER EARTHING RODS

for
WIRELESS
APPARATUS

(U.K. Patent Nos.
495598, 423366, 490040.)



100%
MORE
SURFACE
AREA

Designed to give a low resistance earth contact. Made from solid drawn H.C. copper. The multiple fins ensure larger surface area and better contact with the earth than any driving earth of similar diameter and weight at present on the market; giving nearly 50 per cent. more contact area than a circular rod of equal diameter, or 100 per cent. more than a solid rod of equal weight. About 1 1/2" of the rod is left exposed and the earth lead is simply clamped against the rod by means of the copper clamp ring and screw. No sweating or soldering is required. Supplied in two standard sizes, 18" and 24". Longer rods of similar type can be supplied, if desired, to meet special requirements.

BRITISH INSULATED CABLES LTD.,
CABLE MAKERS AND ELECTRICAL ENGINEERS,
PRESCOT, LANCS. Tel. No. PRESCOT 6571

ERIE Standard CARBON RESISTORS



(10Ω to 9.5 megΩ. Tolerance ± 10%. Wired Ends)
Type No. 4, 1/2 watt - 6d. Type No. 3, 1/2 watt - 6d.
Type No. 2, 1 watt - 1/- Type No. 1, 1/2 watt - 1/6
Type No. 0, 3-5 watt - 2/6

The ERIE S.R.48 RESISTOR KIT

If you wish to secure the S.R.48 Resistor Kit in its original form, as illustrated, we cannot urge you too strongly to order now. It may be necessary for us at any time to substitute a cardboard carton for the pressed steel box which we are at present supplying free of charge. Remember, the S.R.48 Resistor Kit offers you the right replacement in a form equally handy for toolbag, workshop or counter display. Remember, too, that Erie 1/2 watt and 1 watt standard carbon resistors will carry a load of 1 watt and 2 watts respectively, allowing for a 50% overload, and in consequence this kit will cover all your requirements over the 1/2 watt to 2 watt range. The Erie S.R.48 Resistor Kit contains 48 standard carbon resistors, 24 each 1/2 watt, and 1 watt in an assortment of most used values. List Price **36/-**

ERIE REPLACEMENT VOLUME CONTROLS

Erie Replacement Volume Controls are the only fitting companions for Erie Resistors.

STANDARD CONTROLS.

Without Switch - 2/6 With S.P. Switch - 3/6
With D.P. Switch 3/6 C.T. with Switch - 5/6

DUAL AND GANGED CONTROLS

Less Switch - 10/-
With S.P. Switch 10/6. With D.P. Switch 11/-.

Non-standard Spindles 2/- per control extra.

ALSO Vitreous Wirewound Power Resistors.

Send for complete Price List.

ERIE RESISTOR LTD. Carlisle Road, The Hyde, Hendon, N.W.9. Telephone:—Collindale 8011.

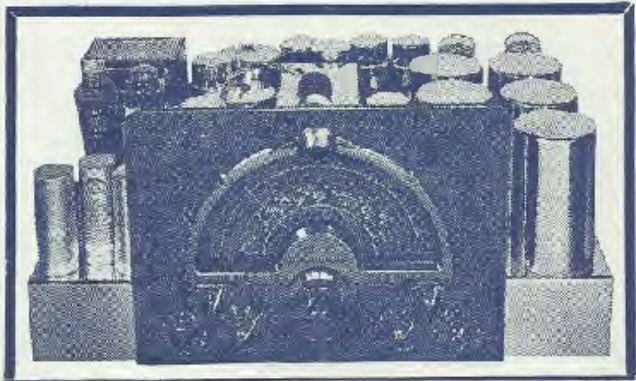

McMURDO SILVER RADIO

The quality receiver with communications receiver performance.

May we send you details?

**THE ERSKINE
LABORATORIES LTD.**
PROSPECT WORKS NORTH STREET
SCALBY, SCARBOROUGH

IS ONE-ROOM-RADIO RESTRICTING YOUR LISTENING?



Get over the difficulty
by installing an

EXTRA SPEAKER

Extension speaker listening is the only satisfactory solution to the problem of providing radio in two or more rooms. The economically priced Stentorian gives a quality of reproduction that will surprise you—they do full justice to the finest receivers—ask your dealer to demonstrate.

Cabinet models from 21/6
Chassis models from 19/3
Literature on application.



CADET CABINET £2-3-6

Stentorian 
THE PERFECT EXTRA SPEAKER FOR ANY SET
WHITELEY ELECTRICAL RADIO CO. LTD., MANSFIELD, NOTTS

95 hrs

“His Master’s Voice” introduce...
*a distinguished new A.C. Table Grand
 offering greatly enhanced performance,
 particularly on short waves.*

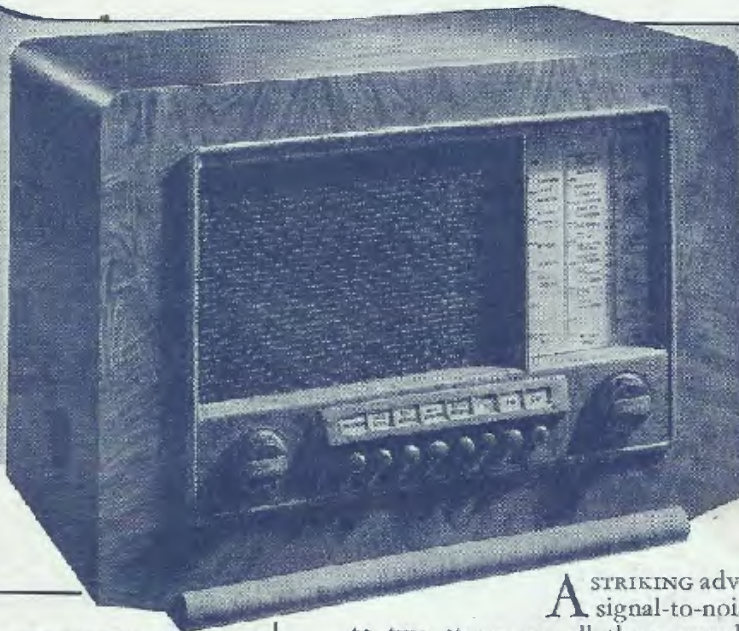

FEATURES :

- High gain aerial circuit.*
- New type steep slope mixer valve.*
- All-wave reception: 16.5 - 52 metres; 192 - 570 metres; 900 - 2,000 metres.*
- Specially designed tone control.*
- Pick-up and external speaker sockets.*
- Press-button tuning for five stations and wave-band switching.*
- 5 watts rated output.*
- Suitable for A.C. Mains, 195 - 255 volts, 50 - 100 cycles.*

MODEL 1106

*5-valve, all-wave, A.C. Table Grand
 with Press-Button Tuning*

PRICE **12** GUINEAS

A STRIKING advance in the direction of greatly improved signal-to-noise ratio, and more effective A.V.C. applied to two stages on all three wavebands—these are among the outstanding features which give the latest H.M.V. Model 1106 a performance considerably ahead of previous designs.

Programme value, particularly on short waves, depends not so much on obtaining a high degree of initial amplification, as on ensuring that the advantage thus gained in sensitivity is not offset by the disadvantage of proportionately increased valve noise.

The problem has been solved by a new high gain aerial circuit giving an initial gain of between 4:1 and 5:1 over the whole wave-range of the receiver, and by a new and highly efficient design of frequency-changer valve which gives a signal amplification from 2½ to 3 times greater, with a slightly lower noise level, than previous types.

In terms of overall performance, the resulting increase in sensitivity is so great that at the lower end of the short wave band, for instance, the gain from aerial to frequency-changer anode is nearly four times up on previous sets of this class.

Further, the much better A.V.C. characteristic of this new valve gives a considerably greater measure of control at low input levels, and also makes it practicable to apply A.V.C. effectively to both the mixer and I.F. stages on short waves, as well as on medium and long waves.

See your H.M.V. dealer about a demonstration, and ask him to show you the measured performance curves of this outstanding receiver.

“HIS MASTER’S VOICE” RADIO